



RODAMIENTOS DE BOLAS EN MATERIALES POLIMÉRICOS

POLYMERIC BALL BEARINGS



CATÁLOGO TÉCNICO GENERAL
GENERAL TECHNICAL CATALOGUE



01.07.12



Política ambiental

El presente **Catálogo Técnico ISB®** ha sido realizado con **material ecológico certificado FSC**.
El proceso productivo del papel se lleva a cabo respetando las normativas vigentes. **DS/EN ISO 14001** e **ISO 9001:2008**.
La plastificación de la portada se realizó utilizando material biodegradable; las tintas para la impresión son de base vegetal.
Por favor continúe Usted también con su compromiso por la protección del medio ambiente.

Environmental policy

*This **ISB® Technical Catalogue** has been produced with **100% ecological material certified FSC**.
Manufacturing process follows the regulations in force: **DS/EN ISO 14001** and **ISO 9001:2008**.
Plasticization of the cover page has been achieved using biodegradable materials, inks used are vegetable based.
Please continue your actions in order to protect the environment and recycle properly.*

PROGRAMA GENERAL DE VENTA

GENERAL SALES PROGRAM



RODAMIENTOS Y COMPONENTES *
BEARINGS AND COMPONENTS *



SOPORTES AUTOALINEANTES *
SELF-ALIGNING BEARING UNITS *



RÓTULAS - CABEZAS DE ARTICULACIÓN - HORQUILLAS *
SPHERICAL PLAIN BEARINGS - ROD ENDS - CLEVISES *



CASQUILLOS*
BUSHES *



CORONAS GIRATORIAS *
SLEWING BEARINGS *



ELECTRICAL MOTORS STANDARD

RODAMIENTOS PARA APLICACIONES "BAJA RUMOROSIDAD" *
BEARINGS FOR "LOW NOISE" APPLICATIONS *



RODAMIENTOS DE AGUJAS *
NEEDLE BEARINGS *

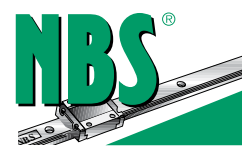

COMPONENTES PARA SISTEMAS LINEALES*
COMPONENTS FOR LINEAR MOTION *



RUEDAS LIBRES *
FREE WHEELS *

Disponibile un stock ampio y completo de rodamientos con entrega inmediata.
Wide and complete assortment of bearings with prompt delivery.



RODAMIENTOS SKF - FAG
SKF - FAG BEARINGS

* Para más información, rogamos solicite el catálogo técnico, disponible también on-line: www.italcuscineti.it

* For further information, please ask for technical catalogue, also available on line: www.italcuscineti.it



CATÁLOGO TÉCNICO GENERAL
GENERAL TECHNICAL CATALOGUE

Distribuidor / *Distributor*

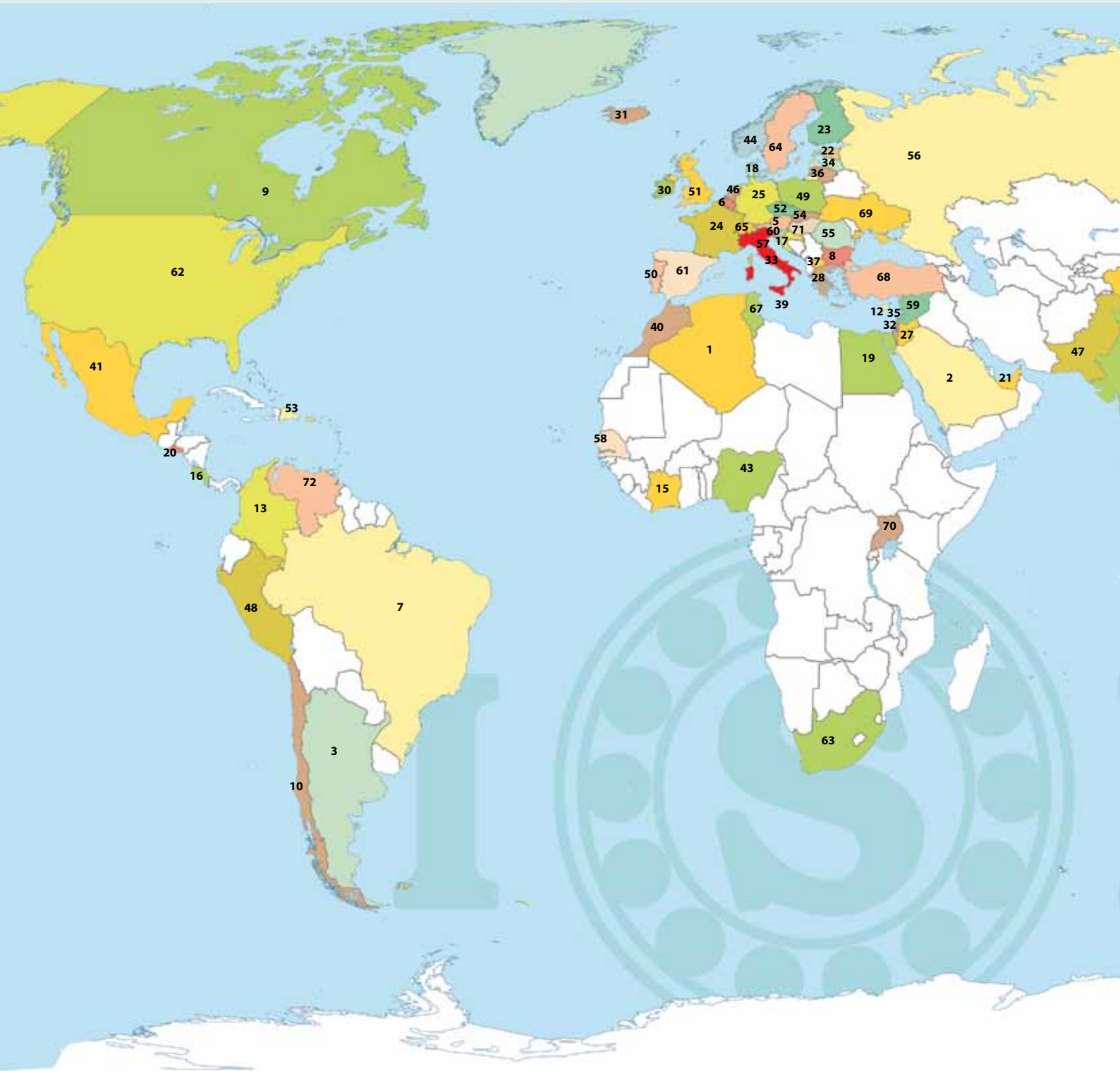

***hora legal (período de marzo a octubre en Italia)**

**summer time (from March to October in Italy)*

hora solar (-1)

standard time (-1)

para las capitales con el horario indicado en rojo no existe una hora legal

time is indicated in red for capitals with no daylight saving time (DST)



	1 ARGELIA (Argel - 11:00)	ALGERIA
	2 ARABIA SAUDITA (Riyadh - 13:00)	SAUDI ARABIA
	3 ARGENTINA (Buenos Aires - 07:00)	ARGENTINA
	4 AUSTRALIA (Canberra - 20:00)	AUSTRALIA
	5 AUSTRIA (Viena - 12:00)	AUSTRIA
	6 BÉLGICA (Bruselas - 12:00)	BELGIUM
	7 BRASIL (Brasília - 07:00)	BRAZIL
	8 BULGARIA (Sofía - 13:00)	BULGARIA
	9 CANADÁ (Ottawa - 06:00)	CANADA
	10 CHILE (Santiago - 06:00)	CHILE
	11 CHINA (Pekín - 18:00)	CHINA
	12 CHIPRE (Nicosia - 13:00)	CYPRUS
	13 COLOMBIA (Bogotá - 05:00)	COLOMBIA
	14 COREA DEL SUR (Seúl - 19:00)	SOUTH KOREA
	15 COSTA DE MARFIL (Abidjan - 10:00)	IVORY COAST
	16 COSTA RICA (San José - 04:00)	COSTA RICA
	17 CROACIA (Zagreb - 12:00)	CROATIA
	18 DINAMARCA (Copenhague - 12:00)	DENMARK
	19 EGIPTO (El Cairo - 13:00)	EGYPT
	20 EL SALVADOR (San Salvador - 04:00)	EL SALVADOR
	21 EMIRADOS ÁRABES UNIDOS (Abu Dhabi - 14:00)	UNITED ARAB EMIRATES
	22 ESTONIA (Tallinn - 13:00)	ESTONIA
	23 FINLANDIA (Helsinki - 13:00)	FINLAND
	24 FRANCIA (París - 12:00)	FRANCE
	25 ALEMANIA (Berlín - 12:00)	GERMANY
	26 JAPÓN (Tokio - 19:00)	JAPAN
	27 JORDANIA (Amman - 13:00)	JORDAN
	28 GRECIA (Atenas - 13:00)	GREECE
	29 INDIA (Nueva Delhi - 15:30)	INDIA
	30 IRLANDA (Dublín - 11:00)	IRELAND
	31 ISLANDIA (Reykjavik - 10:00)	ICELAND
	32 ISRAEL (Jerusalén - 13:00)	ISRAEL
	33 ITALIA (Roma - 12:00)*	ITALY
	34 LETONIA (Riga - 13:00)	LATVIA
	35 LIBANO (Beirut - 13:00)	LEBANON
	36 LITUANIA (Vilnius - 13:00)	LITHUANIA
	37 MACEDONIA (Skopje - 12:00)	MACEDONIA
	38 MALASIA (Kuala Lumpur - 18:00)	MALAYSIA
	39 MALTA (Valletta - 12:00)	MALTA
	40 MARRUECOS (Rabat - 10:00)	MOROCCO
	41 MÉXICO (Ciudad de México - 06:00)	MEXICO
	42 NEPAL (Kathmandú - 15:45)	NEPAL
	43 NIGERIA (Abuja - 11:00)	NIGERIA
	44 NORUEGA (Oslo - 12:00)	NORWAY
	45 NUEVA ZELANDIA (Wellington - 22:00)	NEW ZEALAND
	46 HOLANDA (Ámsterdam - 12:00)	NETHERLANDS
	47 PAQUISTÁN (Islamabad - 16:00)	PAKISTAN
	48 PERÚ (Lima - 05:00)	PERU
	49 POLONIA (Varsovia - 12:00)	POLAND
	50 PORTUGAL (Lisboa - 11:00)	PORTUGAL
	51 REINO UNIDO (Londres - 11:00)	UNITED KINGDOM
	52 REPUB. CHECA (Praga - 12:00)	CZECH REPUBLIC
	53 REPUB. DOMINICANA (Santo Domingo - 06:00)	DOMINICAN REPUBLIC
	54 REPUB. ESLOVACA (Bratislava - 12:00)	SLOVAKIAN REPUBLIC
	55 RUMANÍA (Bucarest - 13:00)	RUMANIA
	56 RUSIA (Moscú - 14:00)	RUSSIA
	57 SAN MARINO (San Marino - 12:00)	SAN MARINO
	58 SENEGAL (Dakar - 10:00)	SENEGAL
	59 SIRIA (Damasco - 13:00)	SYRIA
	60 ESLOVENIA (Liubliana - 12:00)	SLOVENIA
	61 ESPAÑA (Madrid - 12:00)	SPAIN
	62 ESTADOS UNIDOS DE AMÉRICA (Washington - 06:00)	UNITED STATES OF AMERICA
	63 SUDÁFRICA (Pretoria - 12:00)	SOUTH AFRICA
	64 SUECIA (Estocolmo - 12:00)	SWEDEN
	65 SUIZA (Berna - 12:00)	SWITZERLAND
	66 TAIWAN (Taipei - 18:00)	TAIWAN
	67 TUNISIA (Túnez - 11:00)	TUNISIA
	68 TURQUÍA (Ankara - 13:00)	TURKEY
	69 UCRAINA (Kiev - 13:00)	UKRAINE
	70 UGANDA (Kampala - 14:00)	REPUBLIC OF UGANDA
	71 HUNGRÍA (Budapest - 12:00)	HUNGARY
	72 VENEZUELA (Caracas - 06:00)	VENEZUELA



PRODUCCIÓN PRODUCTION

Todos los productos **ISB®** son fabricados exclusivamente por empresas que cuentan con Sistema de Calidad certificado según las normas UNI EN ISO 9001:2008.

All **ISB®** products are manufactured exclusively by companies with UNI EN ISO 9001:2008 certified Quality System.



... laboratorios externos especializados y dotados de modernos instrumentos de medición y control realizan una serie de comprobaciones adicionales.

Laboratorio Control Calidad.



... an additional series of tests are conducted by specialised third party Laboratories using the latest instruments.

Quality Control Laboratory.

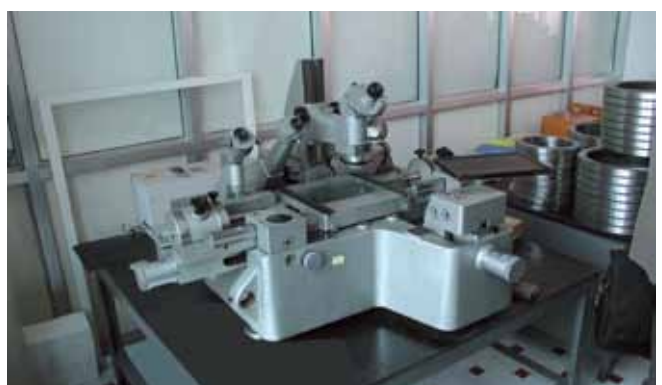
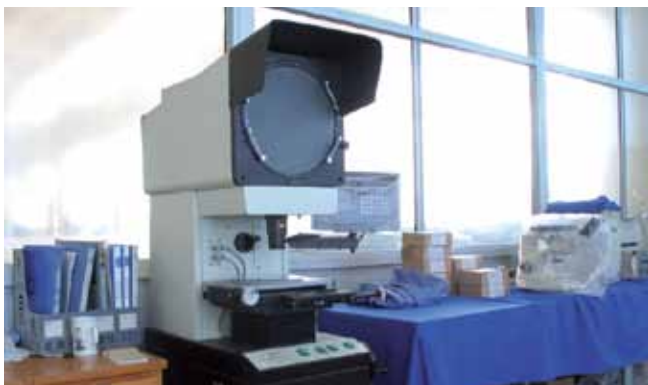

... centro de control de calidad en nuestra sede en ITALIA.
... un staff de Ingenieros técnicos de la Calidad, a su servicio.

... a quality control centre is located in our headquarter in ITALY.
... our staff of technical engineers at your service, for Quality.



AGRICULTURA
CASA
INDUSTRIA
MAQUINARIA
TIEMPO LIBRE
OFICINAS
VEHÍCULOS

AGRICULTURE
HOME
INDUSTRY
MACHINERIES
FREE TIME
OFFICE
VEHICLES



Las numerosas líneas de rodamientos y componentes **ISB®** permiten satisfacer las exigencias en los más diversos sectores de aplicación. La amplia gama y la calidad de los productos permiten garantizar aplicaciones también en condiciones de empleo exigentes. Los rodamientos y componentes **ISB®**, abarcan un amplísima producción que incluye todas las tipologías y es idónea por lo tanto para satisfacer las más variadas exigencias aplicativas.

*The diverse product lines of **ISB®** bearings and components make it possible to satisfy the needs of a wide variety of fields of application. The wide range and quality of products is also a guarantee for heavy duty applications. **ISB®** bearings and components are available in versions across-the-board and can meet the requirements of a wide variety of demanding applications.*



RODAMIENTOS
BEARINGS

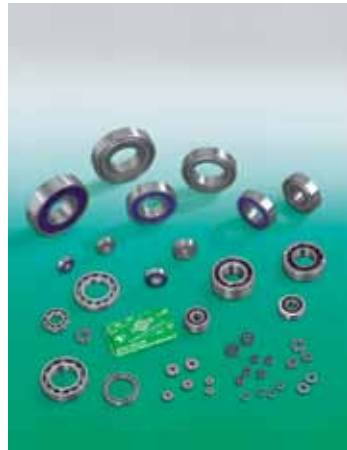

RODAMIENTOS PARA APLICACIONES "BAJA RUMOROSIDAD"
BEARINGS FOR "LOW NOISE" APPLICATIONS



SOPORTES AUTOALINEANTES
SELF-ALIGNING BEARING UNITS



RÓTULAS - CABEZAS DE ARTICULACIÓN - HORQUILLAS
*SPHERICAL PLAIN BEARINGS
ROD ENDS - CLEEVES*



CASQUILLOS
BUSHES



RODAMIENTOS DE GRANDES DIMENSIONES
LARGE BEARINGS



CORONAS GIRATORIAS
SLEWING BEARINGS



RODAMIENTOS DE BOLAS EN MATERIALES POLIMÉRICOS
POLYMERIC BALL BEARINGS



RODAMIENTOS BONDERIZADOS PARA ALTAS TEMPERATURAS
BONDERIZED BEARINGS FOR HIGH TEMPERATURES



**BOLAS TRANSPORTADORAS
BOLAS DE PRECISIÓN
RODILLOS Y AGUJAS DE PRECISIÓN**
*BALL TRANSFER UNITS
PRECISION BALLS
PRECISION ROLLERS AND NEEDLES*



OBTURACIONES METÁLICAS PARA RODAMIENTOS
METALLIC SEALS FOR BEARINGS



PRODUCTOS DE ACERO INOXIDABLE
STAINLESS STEEL PRODUCTS



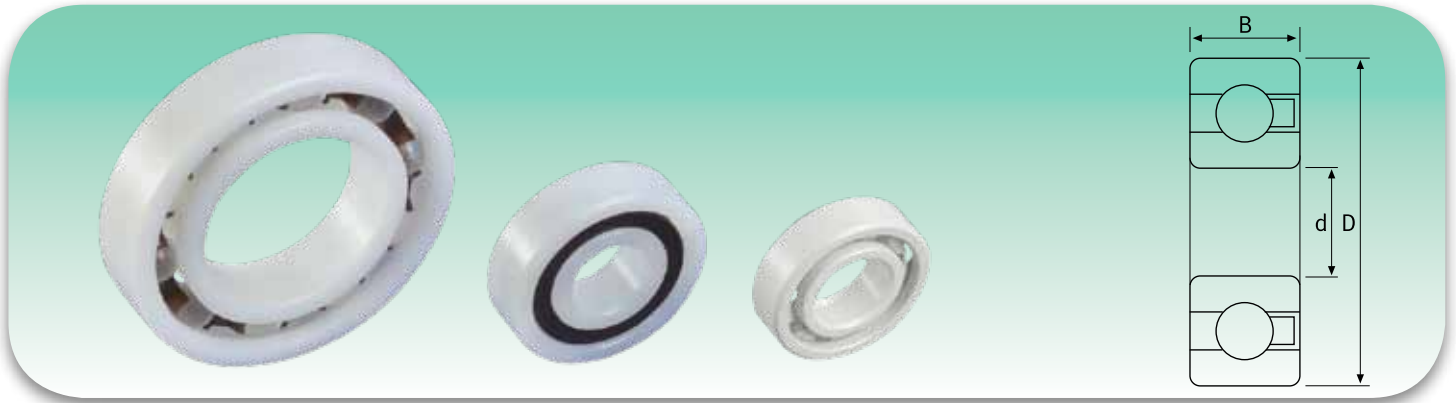

Tipo Type	Dimensiones - Dimensions			Coeficientes de carga (N) Load ratings (N)		N° de giros max/min Speed max/min
	d	D	B	Estático / Static	Dinámico / Dynamic	
	mm					rpm
607	7	19	6	40	60	2 600
608	8	22	7	55	80	2 200
609	9	24	7	60	90	2 050
623	3	10	4	30	45	4 500
624	4	13	5	40	60	3 600
625	5	16	5	45	65	3 050
626	6	19	6	50	70	2 600
627	7	22	7	55	85	2 200
629	9	26	8	70	100	1 900
6000	10	26	8	90	130	1 900
6001	12	28	8	110	160	1 750
6002	15	32	9	130	190	1 550
6003	17	35	10	170	240	1 400
6004	20	42	12	200	300	1 200
6005	25	47	12	240	360	1 050
6006	30	55	13	280	420	900
6007	35	62	14	320	480	800
6008	40	68	15	350	520	750
6009	45	75	16	380	560	650
6010	50	80	16	390	580	600
6011	55	90	18	400	600	550
6012	60	95	18	440	670	500
6013	65	100	18	440	670	475
6014	70	110	20	460	710	450
6200	10	30	9	130	170	1 650
6201	12	32	10	150	220	1 550
6202	15	35	11	170	250	1 400
6203	17	40	12	220	320	1 250
6204	20	47	14	270	420	1 050
6205	25	52	15	320	480	950
6206	30	62	16	360	550	800
6207	35	72	17	410	620	700
6208	40	80	18	440	660	625
6209	45	85	19	470	720	580
6210	50	90	20	540	770	550
6211	55	100	21	600	800	500
6212	60	110	22	630	880	450
6300	10	35	11	190	280	1 400
6301	12	37	12	210	310	1 300
6302	15	42	13	260	370	1 200
6303	17	47	14	300	450	1 050
6304	20	52	15	350	530	950
6305	25	62	17	400	600	725
6306	30	72	19	460	700	675
6307	35	80	21	490	750	600
6309	45	100	25	540	900	500



Tipo Type	Dimensiones - Dimensions			Coeficientes de carga (N) Load ratings (N)		Nº de giros max/min Speed max/min
	d	D	B	Estático / Static	Dinámico / Dynamic	
	mm					rpm
16002	15	32	8	130	190	1 500
16003	17	35	8	160	240	1 400
16004	20	42	8	190	290	1 150
16005	25	47	8	210	310	1 050
16006	30	55	9	240	370	900
16007	35	62	9	290	430	800
16008	40	68	9	300	450	750
16009	45	75	10	330	500	650

Tipo Type	Dimensiones - Dimensions			Coeficientes de carga (N) Load ratings (N)		Peso Weight
	d	D	B	Estático / Static	Dinámico / Dynamic	
	mm					(g)
61700	10	15	3	61	33	9
61701	12	18	4	64	39	18
61702	15	21	4	69	47	21
61703	17	23	4	72	52	24
61704	20	27	4	107	79	30
61705	25	32	4	115	93	36
61706	30	37	4	123	107	48
61707	35	44	5	130	111	54
61708	40	50	6	138	115	60
61709	45	55	6	146	119	66
61710	50	62	6	155	122	72
61800	10	19	5	102	50	30
61801	12	21	5	114	63	36
61802	15	24	5	126	75	42
61803	17	26	5	159	93	48
61804	20	32	7	240	147	108
61805	25	37	7	258	177	132
61806	30	42	7	273	204	156
61807	35	47	7	285	231	180
61808	40	52	7	297	252	198
61809	45	58	7	372	324	240
61810	50	65	7	396	366	312
61811	55	72	9	528	486	498
61900	10	22	6	162	75	60
61901	12	24	6	174	87	66
61902	15	28	7	258	135	102
61903	17	30	7	276	153	108
61904	20	37	9	381	222	216
61905	25	42	9	420	273	246
61906	30	47	9	435	300	270
61907	35	55	10	654	465	438
61908	40	62	12	822	597	672
61909	45	68	12	846	654	792
61910	50	72	12	870	702	798
61911	55	80	13	996	846	1 110

RODAMIENTOS EN MATERIAL POLIMÉRICO MEDIDAS EN PULGADAS

POLYMERIC BALL BEARINGS INCHES SIZES



Tipo Type	Dimensiones - Dimensions						Coeficientes de carga (N) Load ratings (N)		N° de giros max/min Speed max/min
	d		D		B		Estático / Static	Dinámico / Dynamic	
	mm	inch	mm	inch	mm	inch			rpm
I4	6,35	¼	15,88	⅝	5	0,196	40	60	3 600
I4 A	6,35	¼	19,05	¾	5,56	⅞ ₃₂	50	70	2 600
I4 AW	6,35	¼	19,05	¾	7,14	⅞ ₃₂	50	70	2 600
I6	9,53	⅜	22,22	⅞	5,56	⅞ ₃₂	60	80	2 200
I6 A	9,53	⅜	22,22	⅞	7,14	⅞ ₃₂	60	80	2 200
I8	12,7	½	28,58	1⅞	6,35	¼	110	160	1 750
I8 A	12,7	½	28,58	1⅞	9,53	⅜	110	160	1 750
I10	15,88	⅝	34,93	1⅜	7,14	⅞ ₃₂	170	250	1 400
I10 A	15,88	⅝	34,93	1⅜	9,53	⅜	170	250	1 400
I10 B	15,88	⅝	34,93	1⅜	11,11	⅞ ₁₆	170	250	1 400
I12	19,05	¾	41,28	1⅝	7,94	⅞ ₁₆	200	300	1 200
I16	25,4	1	50,8	2	12,7	½	240	360	1 050

PERNOS LIBRES EN MATERIAL POLIMÉRICO

POLYMERIC STUD TYPE TRACK ROLLERS

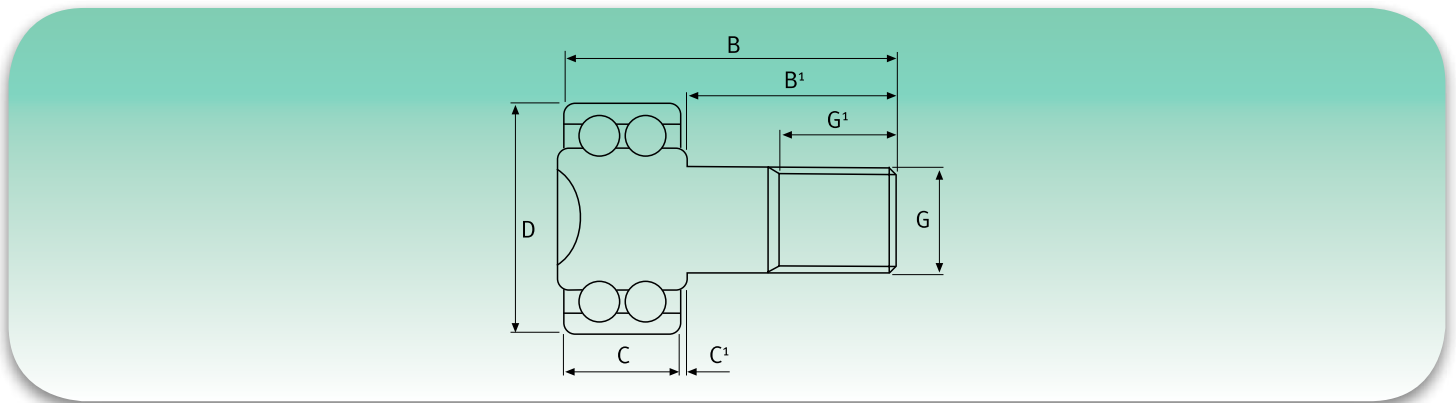

Tipo Type	Dimensiones - Dimensions							Coeficientes de carga (N) Load ratings (N)		N° de giros max/min Speed max/min
	D	C	B	B¹	C¹	G	G¹	Estático / Static	Dinámico / Dynamic	
	mm									rpm
KR 16	16	11	28	16	0,6	M6	8	45	65	3 050
KR 19	19	11	32	20	0,6	M8	10	50	70	2 600
KR 22	22	12	36	23	0,6	M10x1	12	55	80	2 200
KR 26	26	12	36	23	0,6	M10x1	12	70	100	1 900
KR 30	30	14	40	25	0,6	M12x1,5	13	110	160	1 650
KR 32	32	14	40	25	0,6	M12x1,5	13	150	220	1 550
KR 35	35	18	52	32,5	0,8	M16x1,5	17	170	250	1 400
KR 40	40	20	58	36,5	0,8	M18x1,5	19	220	320	1 250
KR 47	47	24	66	40,5	0,8	M20x1,5	21	260	370	1 050

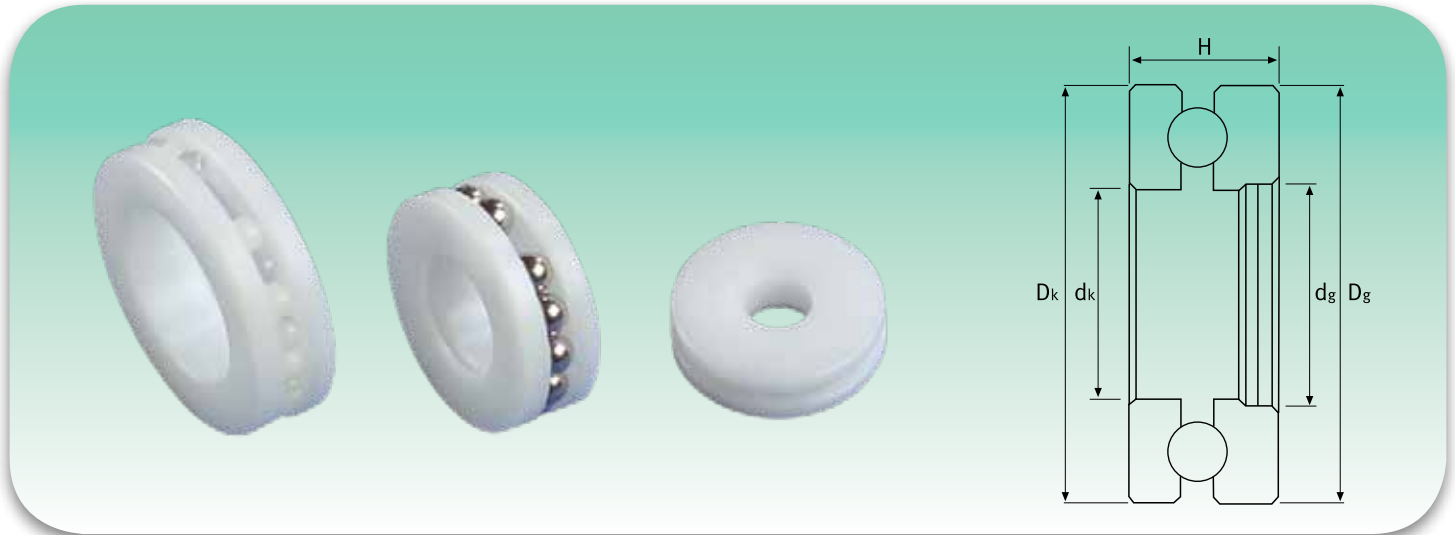

Tipo Type	Dimensiones - Dimensions					Capacidad de carga (N) Rating Loads (N)	Nº de giros max/min Speed max/min rpm
	dk	Dg	dg	Dk	H		
	mm						
51100	10	24	11	23	9	200	600
51200	10	26	11	25	11	210	600
51101	12	26	13	25	9	320	540
51201	12	28	13	27	11	330	540
51102	15	28	16	27	9	500	500
51202	15	32	16	31	12	520	500
51103	17	30	18	29	9	570	480
51203	17	35	18	34	12	600	480
51104	20	35	21	34	10	650	460
51204	20	40	21	39	14	690	460
51105	25	42	26	41	11	710	410
51205	25	47	26	46	15	750	400
51305	25	52	26	51	18	820	380
51106	30	47	31	46	11	760	400
51206	30	52	31	51	16	820	375
51306	30	60	31	59	21	860	360
51107	35	62	36	51	12	810	390
51207	35	68	36	61	18	870	365
51307	35	60	36	67	24	950	350
51108	40	68	41	59	13	890	375
51208	40	78	41	67	19	940	350
51308	40	65	41	77	26	1 000	320
51109	45	73	46	64	14	950	360
51209	45	85	46	72	20	1 010	330
51309	45	70	46	84	28	1 070	310
51110	50	78	51	69	14	1 020	340
51210	50	75	51	77	22	1 100	310
51310	50	95	51	94	31	1 180	290
51111	55	78	56	77	16	1 050	310
51211	55	90	56	89	25	1 160	280
51311	55	105	56	104	36	1 270	270
51112	60	85	61	84	17	1 120	280
51212	60	95	62	94	26	1 300	250
51312	60	110	63	109	35	1 500	240

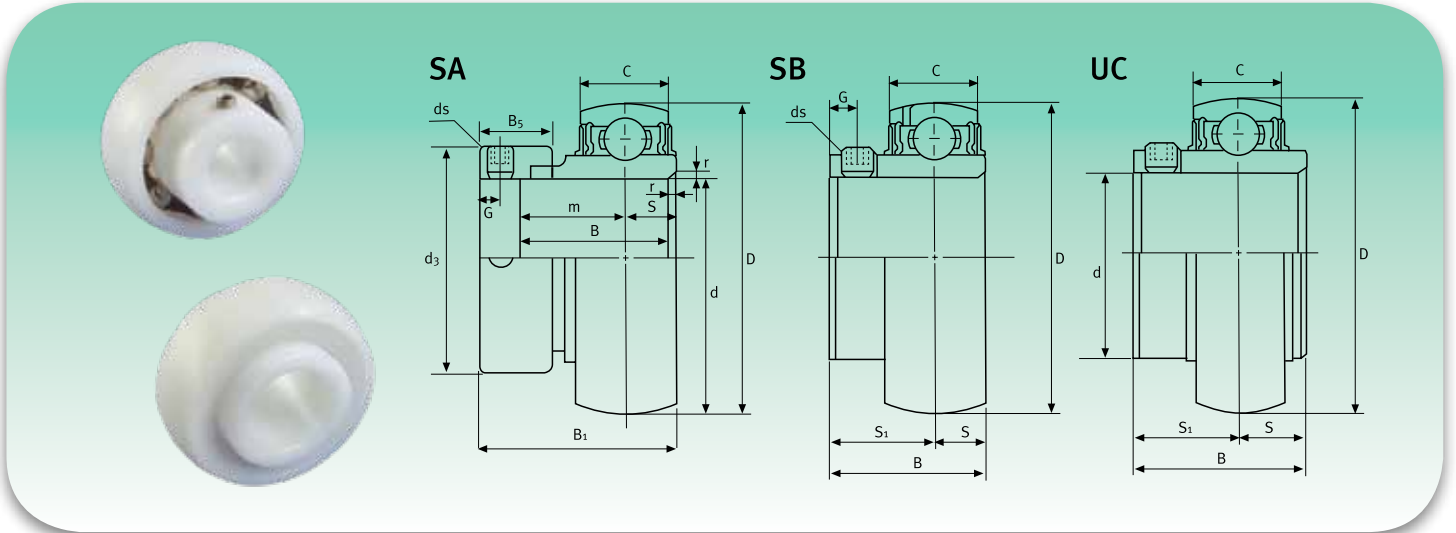

SA 200

Anillo de ajuste excéntrica / Eccentric collar locking

Tipo Type	Dimensiones - Dimensions												Carga rodamiento (Kg) Rating Load [$d_3 N$] (K_r)		Peso Weight (g)
	d	C	D	B	r	S	m	B ₁	d ₃	B ₅	G	ds	Dinámico Dynamic	Estático Static	
	mm														
SA204	20	14	47	21,5	1,5	7	14,5	31	33,3	13,5	5	M6x0,75	60,6	37,8	100
SA205	25	15	52	21,5	1,5	7,5	14	31	38,1	13,5	5	M6x0,75	66	42,6	110
SA206	30	16	62	23,8	1,5	8	15,8	35,7	44,5	15,9	6	M8x1	93	61,2	180
SA207	35	17	72	25,4	2	8,5	16,9	38,9	55,6	17,5	6,5	M8x1	121,8	84	300
SA208	40	19	80	30,2	2	9,5	21,2	43,7	60,3	18,3	6,5	M8x1	138	96	380
SA209	45	19	85	30,2	2	9,5	20,7	43,7	63,5	18,3	6,5	M8x1	154,2	108,6	400
SA210	50	20	90	30,2	2	10	21,2	43,7	69,9	18,3	6,5	M10x1,25	165,6	120,6	480

SB 200

Ajuste con clavijas / Set screw locking

Tipo Type	Dimensiones - Dimensions									Carga rodamiento (Kg) Rating Load [$d_3 N$] (K_r)		Peso Weight (g)
	d	C	D	B	S	S ₁	G	ds	Dinámico Dynamic	Estático Static		
	mm											
SB204	20	14	47	25	7	18	4,5	M6x0,75	60,6	37,8	80	
SB205	25	15	52	27	7,5	19,5	5	M6x0,75	66	42,6	100	
SB206	30	16	62	30	8	22	5,5	M6x0,75	93	61,2	150	
SB207	35	17	72	32	8,5	23,5	6	M8x1	121,8	84	220	
SB208	40	19	80	34	9,5	25	8	M8x1	138	96	270	
SB209	45	19	85	41,2	10,2	31	8	M8x1	154,2	108,6	480	
SB210	50	20	90	43,5	10,9	32,6	9	M10x1,25	165,6	120,6	520	

Tipo Type	Dimensiones - Dimensions						Carga rodamiento (Kg) Rating Load [$d_3 N$] (K_r)		Peso Weight (g)
	d	D	B	C	S ₁	S	Dinámico Dynamic	Estático Static	
	mm								
UC200	10	47	31	17	18,3	12,7	42	27	300
UC201	12	47	31	17	18,3	12,7	42	27	300
UC202	15	47	31	17	18,3	12,7	42	27	300
UC203	17	47	31	17	18,3	12,7	42	27	300
UC204	20	47	31	17	18,3	12,7	42	27	300
UC205	25	52	34,1	17	19,8	14,3	48	32	460
UC206	30	62	38,1	19	22,2	15,9	55	36	690
UC207	35	72	42,9	20	25,4	17,5	62	41	890
UC208	40	80	49,2	21	30,2	19	66	44	1 080

Las tolerancias indicadas a continuación son válidas solo para rodamientos con anillo en POM.

These tolerances are only for bearings with outer ring of POM.

Diámetro interior Inner diameter	Tolerancia Tolerances
3 - 17 mm.	± 0,03 mm.
20 - 50 mm.	± 0,04 mm.
55 - 70 mm.	± 0,05 mm.
-	-

Diámetro exterior Outer diameter	Tolerancia Tolerances
10 - 30 mm.	± 0,04 mm.
35 - 47 mm.	± 0,05 mm.
52 - 80 mm.	± 0,06 mm.
90 - 125 mm.	± 0,08 mm.

Altura Width	Tolerancia Tolerances
4 - 8 mm.	- 0,1 mm.
10 - 14 mm.	- 0,1 mm.
14 - 20 mm.	- 0,1 mm.
-	-

RODAMIENTOS MEDIDAS EN PULGADAS

BEARINGS INCHES SIZES

Diámetro interior Inner diameter	Tolerancia Tolerances
$\frac{1}{8}$ - $\frac{11}{16}$	± 0,0012
$\frac{3}{4}$ - 2	± 0,0016
$2\frac{1}{8}$ - $2\frac{3}{4}$	± 0,0020
-	-

Diámetro exterior Outer diameter	Tolerancia Tolerances
$\frac{3}{8}$ - $1\frac{1}{8}$	± 0,0016
$1\frac{3}{8}$ - $1\frac{7}{8}$	± 0,0020
$2\frac{1}{8}$ - $3\frac{1}{8}$	± 0,0024
$3\frac{1}{2}$ - 5	± 0,0032

Altura Width	Tolerancia Tolerances
$\frac{5}{32}$ - $\frac{5}{16}$	- 0,04
$\frac{7}{16}$ - $\frac{9}{16}$	- 0,04
$\frac{5}{8}$ - $\frac{7}{8}$	- 0,04
-	-

Productos químicos <i>Chemical products</i>	Temperatura C° <i>Temperature C°</i>	% Días de inmersión <i>% Immersion days</i>	% Resistencia a la fuerza <i>% Retention of strength</i>
Ácidos / Acids			
10% Clorhídrico <i>Hydrochloric</i>	23	30	89
	23	90	85
	23	180	82
10% Sulfúrico <i>Sulfuric</i>	23	30	97
	23	90	94
	23	180	90
30% Sulfúrico <i>Sulfuric (battery)</i>	23	30	97
	23	180	96
	66	30	84
	66	180	35
10% Acético <i>Acetic</i>	23	30	89
	23	180	88
Bases / Bases			
5% Hidróxido de potasio <i>Potassium Hydroxide</i>	23	30	83
	23	90	10
10% Hidróxido de Sodio <i>Sodium Hydroxide</i>	23	30	2
	23	180	/
10% Hidróxido de Amonio <i>Ammonium Hydroxide</i>	23	30	90
	23	90	87
	23	180	58
Solventes Orgánicos / Organic Solvents			
Alcohol Etilico <i>Ethyl Alcohol</i>	23	30	99
	23	180	94
Alcohol Metílico <i>Methyl Alcohol</i>	23	30	91
	23	180	76
Alcohol isopropileno <i>Isopropyl Alcohol</i>	23	30	100
	23	180	100
Alcohol isopropileno y Agua (50:50) <i>Isopropyl Alcohol and Water (50:50)</i>	23	30	93
	23	180	96
Trementina <i>Turpentine</i>	23	180	92
	23	30	66
Acetona <i>Acetone</i>	23	180	63
	23	30	90

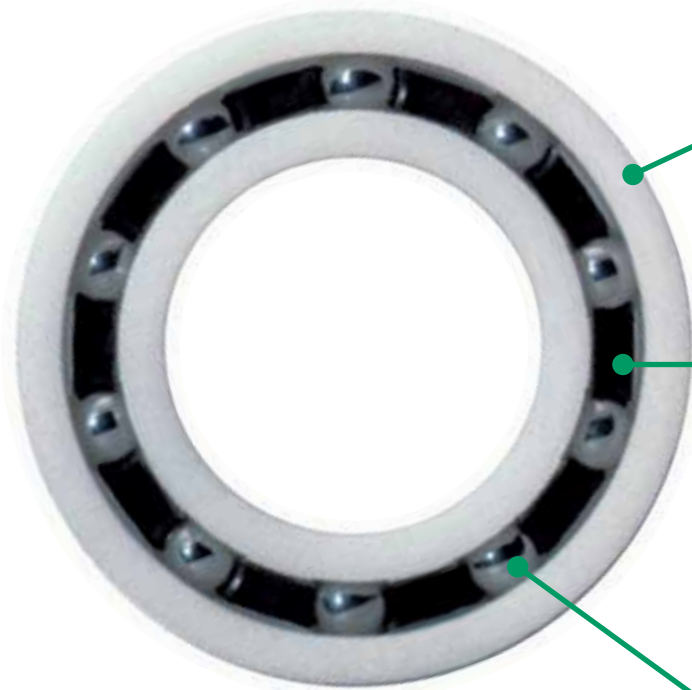

Anillos - Rings

- POM
- PP
- PE
- PET
- PTFE
- PEEK
- PVDF
- PPS
- PI

Jaulas - Cages

- PA
- PP
- PET
- PTFE
- PEEK
- PVDF
- PPS
- PI
- Llenado pleno
Full Complement

Bolas - Balls

- Vidrio - Glass
- Vidrio de Borosilicato
Borosilicate Glass
- AISI 314C/316C
- AISI 420C/440C
- Titanio - Titan
- Cerámica Si3N4
Ceramics Si3N4
- Cerámica Al2O3
Ceramics Al2O3
- POM
- PP
- PA

Aplicaciones - Applications	Anillos - Rings		Jaulas - Cages		Bolas - Balls	
	Materiales aconsejados - Recommended materials					
Transportadores - Conveyor systems Acondicionadores - Air conditioning	<input checked="" type="checkbox"/>	POM	<input type="checkbox"/>	PA	<input type="checkbox"/>	AISI 420C/440C
Pulidoras - Electro plating	<input checked="" type="checkbox"/>	PP	<input checked="" type="checkbox"/>	PP	<input type="checkbox"/>	Vidrio - Glass
Máquinas alimenticias - Food processing	<input checked="" type="checkbox"/>	POM	<input type="checkbox"/>	PA	<input type="checkbox"/>	AISI 314C/316C
Aplicaciones neumáticas - Vacuum applications	<input checked="" type="checkbox"/>	PVDF	<input checked="" type="checkbox"/>	PVDF	<input type="checkbox"/>	Vidrio - Glass
Procesos para hilatura - Fiber processing	<input checked="" type="checkbox"/>	POM	<input type="checkbox"/>	PA	<input type="checkbox"/>	Vidrio - Glass
Hornos - Conveyor ovens	<input checked="" type="checkbox"/>	PEEK	<input checked="" type="checkbox"/>	PEEK	<input type="checkbox"/>	Vidrio - Glass
Máquinas textiles - Textile finishing	<input checked="" type="checkbox"/>	POM	<input type="checkbox"/>	PA	<input type="checkbox"/>	AISI 314C/316C
Aparatos médicos - Medical apparatus	<input type="checkbox"/>	PET	<input type="checkbox"/>	PET	<input type="checkbox"/>	AISI 314C/316C
Esterilizadores - Medical sterilization	<input type="checkbox"/>	PPS	<input type="checkbox"/>	PPS	<input type="checkbox"/>	Vidrio - Glass
Equipos revelado fotografía - Photo processing	<input checked="" type="checkbox"/>	PP/PET	<input checked="" type="checkbox"/>	PP/PET	<input type="checkbox"/>	AISI 314C/316C
Ordenadores - Computer assembly	<input checked="" type="checkbox"/>	POM	<input type="checkbox"/>	PA	<input type="checkbox"/>	Vidrio - Glass
Aplicaciones automovilísticas para altas temperaturas Automotive applications for high temperature	<input type="checkbox"/>	PPS	<input type="checkbox"/>	PPS	<input type="checkbox"/>	AISI 314C/316C
Aplicaciones automovilísticas - Automotive applications	<input checked="" type="checkbox"/>	POM	<input type="checkbox"/>	PA	<input type="checkbox"/>	AISI 314C/316C
Construcciones modelismo ultraligero Model and lightweight constructions	<input checked="" type="checkbox"/>	POM	<input type="checkbox"/>	PA	<input type="checkbox"/>	Vidrio - Glass

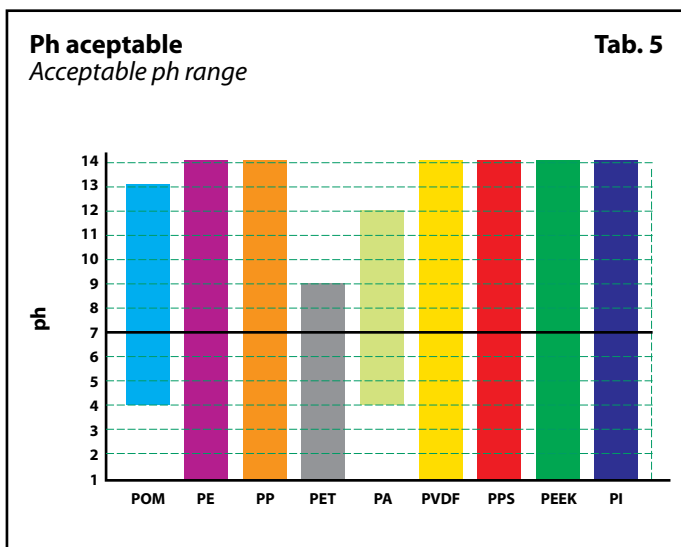
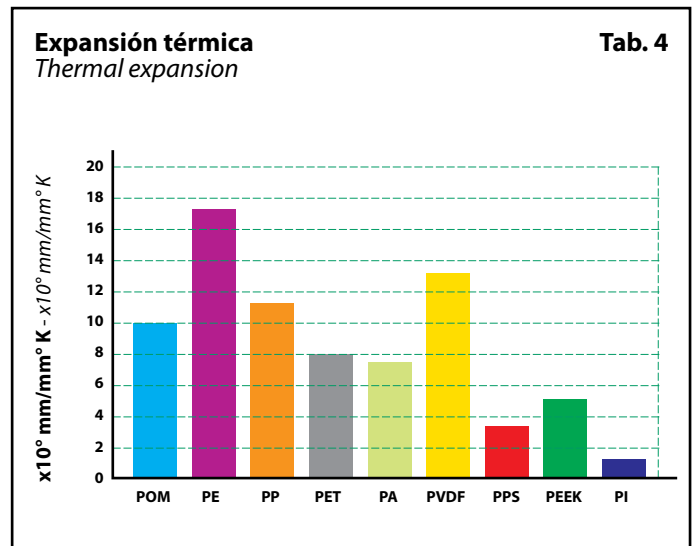
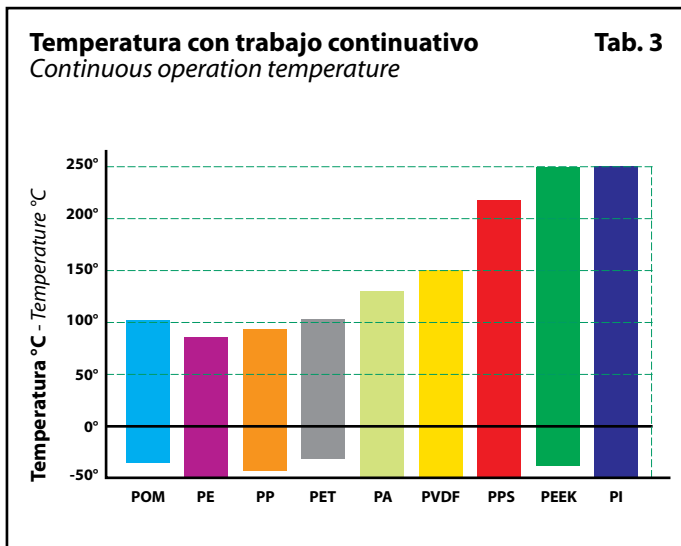
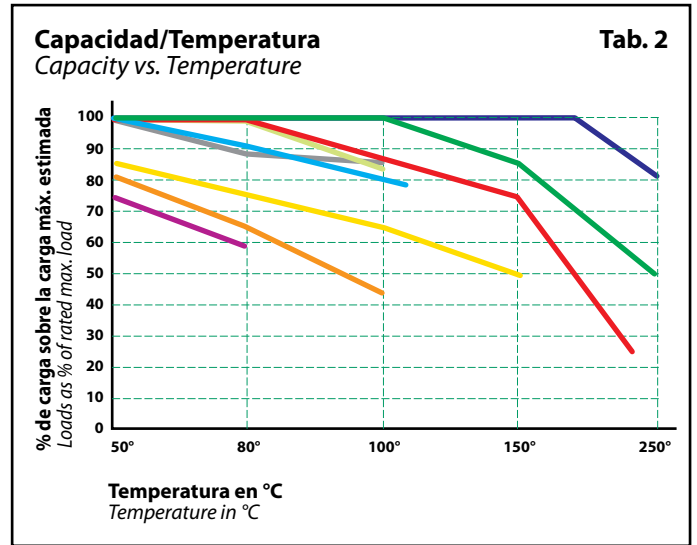
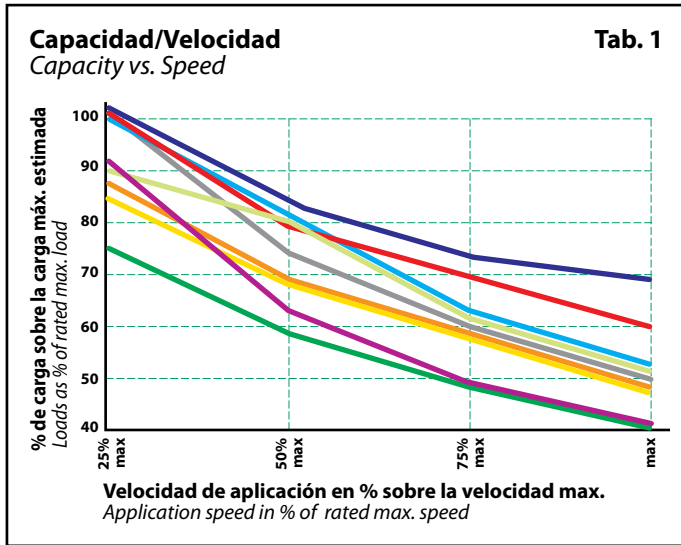

POM Determinación del coeficiente de carga aproximado relativo a aplicaciones estándares.

PE Tipo: 6210 con anillos en POM (tipo de rodamiento expuesto en la pág. 1)
Temperatura de servicio: 80°C (valor indicativo)
Velocidad de rotación: 225 n° revol. max/min (valor indicativo)
Carga dinámica: 770 N (valor expuesto en la pág. 1)

PP Considerando los valores antes indicados, como ejemplo, multiplicar el valor primero expresado en la tab. 1 y luego en la tab. 2.
El resultado que se obtiene será el coeficiente dinámico aproximado que se deberá tener en cuenta para aplicaciones estándares.

PET 770 N x 80% = 616 N x 90% = 554,40 N

PA En las primeras aplicaciones es aconsejable efectuar siempre un test sobre los rodamientos.

PVDF How to calculate the approximate load rating for standard application.
Type: 6210 with POM rings (bearing type showed at page 1)
Working temperature: 80°C (indicative value)
Rotation speed: 225 max/min rpm (indicative value)
Dynamic load: 770 N (value showed at page. 1)

PPS Consider the above value and multiply those once for the value expressed in table 1 and after in table2. The result is the approximate load rating to consider in case of standard application

PEEK 770 N x 80% = 616 N x 90% = 554,40 N

PI We always suggest to make a test on the bearings during initial applications



©Copyright **I S B**[®]

Está prohibida la reproducción, incluso parcial, del contenido de este Catálogo Técnico. No se acepta ningún tipo de responsabilidad en caso de errores u omisiones. Las medidas no son vinculantes. Marca registrada Italia-EU.

*The reproduction, even partial, of the contained concerning this technical catalogue, is forbidden. Liability for possible errors and/or omissions are not accepted. Sizes are not binding.
™ Registered in Italy-EU.*



RODAMIENTOS DE BOLAS EN MATERIALES POLIMÉRICOS
POLYMERIC BALL BEARINGS

01.07.2012 ©Copyright 



79991030

