

ctrlX
AUTOMATION

X I/O

rexroth

ctrlX CORE

X4

SD



rexroth

ctrlX CORE

X4

SD

XF54

F59

A NEW WORLD OF AUTOMATION

The production world is changing and along with it the challenges it faces. Rigid, complex automation systems are no longer a right fit in a world where markets are characterized by ever shorter product life cycles and increasingly tougher competition.

The answer to the new challenges facing industry is: ctrlX AUTOMATION.

A new level of agility is needed to keep pace with the global speed of innovation. This is

precisely where Bosch Rexroth's vision of the "Factory of the Future" comes into play: only the walls, the floor and the ceiling of the factory will remain in place – everything else is flexible. The Factory of the Future dynamically reacts to demands and always offers the ideal solution.

This vision marks the beginning of a new world of automation with an automation platform that focuses systematically on the user. The developers have left no stone unturned in their quest to always find the best solution: an automation platform that is flexible and scalable through and through with maximum openness at all levels and interfaces.

XG31.1



ctrlX
SAFETY

ctrlX
CORE

XG41





**NO GOOD
REASONS.
JUST PERFECT
SOLUTIONS.**

10 arguments for ctrlX AUTOMATION



**A 360°
SOLUTION.
FOR STRAIGHT,
FORWARD
DECISIONS.**

1

A COMPLETE AUTOMATION SOLUTION

[ctrlX AUTOMATION](#) provides all the elements required for complete automation solutions. The system is extremely scalable and covers the requirements for practically all applications.

The system functions complement each other perfectly and can also be extended by apps, third-party hardware and software thanks to the absolute openness of the system.

Offering the best possible networking capability, the automation system can also be connected with just about all relevant automation interfaces and protocols, and offers complete freedom in the choice of development environment and programming language.

Systematically flexible:

- ▶ Maximum scalability and extensibility
- ▶ Perfectly harmonized system functions
- ▶ Virtually all common interfaces and programming languages supported



ctrlX IOT
Built-in security



ctrlX PLC
IEC and non-IEC



ctrlX WORKS
Runtime and engineering



ctrlX MOTION
Motion, Robotics and CNC



ctrlX SAFETY
SafeLogic and SafeMotion



ctrlX DRIVE
Drives and motors



ctrlX I/O
EtherCAT and
Gigabit Ethernet



ctrlX CORE
CPU and power



ctrlX IPC
Box and panel



ctrlX HMI
Hardware and software

2

LESS IS MORE

ctrlX AUTOMATION reduces:

- ▶ Space requirements
 - ▶ Installation times
- ▶ Control cabinet sizes
 - ▶ Service and spare parts requirements
 - ▶ Logistics work
 - ▶ Transaction costs

More compact machines and systems, less hardware, faster installation, and significantly reduced software installations – all of this is possible thanks to [ctrlX AUTOMATION](#). That's because when developing all components and functions, the developers focused where possible on reducing components and complexity and minimizing footprint. Right down to the smallest detail. The space required is reduced significantly since the installation size of all automation components is up to 50% smaller on average. Many individual components that were required to date are no longer necessary thanks to the dramatic reduction in component diversity and functional integration. This simplifies the ordering and delivery logistics as well as the replacement procurement. The systematic use of web technology reduces the software installations required and enables maximum flexibility in terms of the hardware used for engineering, diagnostics, and service.

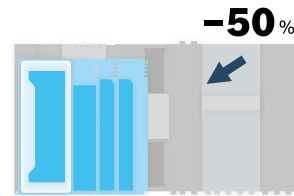

CPU AND I/O

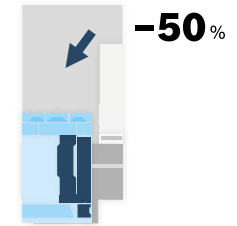

DRIVES

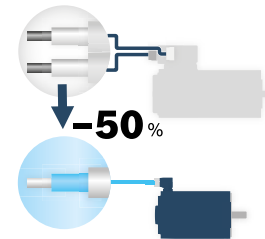
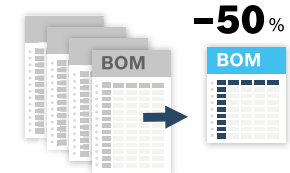
HARDWARE
INSTALLATIONBOM
POSITIONS

MOTORS

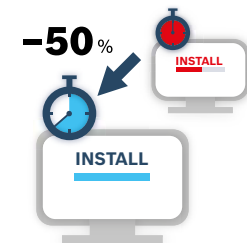
SOFTWARE
INSTALLATIONS

The background is a complex, futuristic mechanical interface. It features a central circular dial with a vertical scale and a horizontal line, resembling a pressure gauge or a control knob. The dial is surrounded by various components, including several glowing blue circular lights and intricate blue and red metallic structures. The overall aesthetic is high-tech and industrial. The text is overlaid on this background in a bold, white, sans-serif font.

**LIKE SCIENCE
FICTION.
JUST WITH LESS
SPACE.**



**NON-STOP
PERFORMANCE.
REAL-TIME
CONTROL.**

3

CONSISTENT PERFORMANCE

The [ctrIX CORE](#) is the powerful heart that beats inside [ctrIX AUTOMATION](#). A high-performance 64-bit multicore CPU forms the basis for all automation topologies – regardless of whether PC-based, as an embedded controller or integrated in the drive. It therefore breaks the typical boundaries between the device platforms. The performance of a ctrIX CORE CPU is more than adequate for practically all automation tasks and, for example, enables synchronization of more than 200 servo drives. Future CPU upgrades are guaranteed to require no software adaptations.



ctrIX CORE offers:

- ▶ Maximum performance
- ▶ Universal use in all devices and topologies
- ▶ Long-term availability thanks to full upgrade compatibility
- ▶ Service support over the long-term with guaranteed availability



ctrIX
CORE

ctrIX DRIVE



ctrIX
CORE

ctrIX CORE



ctrIX
CORE

ctrIX IPC

4

CONNECTIVITY AT ITS BEST



ctrlX I/O offers:

- ▶ Maximum freedom of design in automation
 - ▶ The most connectible system
 - ▶ Long-term availability thanks to systematic openness

Flexible automation solutions demand connectivity. And as the system boasting the best possible connectivity, [ctrlX AUTOMATION](#) focuses uncompromisingly on standardized as well as sector and manufacturer-neutral interfaces. In addition to EtherCAT, the system also supports PROFINET and IO-Link. More than 30 interfaces to IT systems such as OPC UA and MQTT ensure seamless communication within the entire Factory of the Future.

[ctrlX I/O](#) provides a virtually unlimited portfolio of powerful interfaces. Analog and digital I/Os or encoder interfaces are used for connecting additional components or for system enhancements and for communication with external infrastructures. They enable direct control of small and stepper motors.



**ALWAYS
CONNECTED.
TO ALMOST
EVERYTHING.**

5

UNIFORM ARCHITECTURE

Fully adaptable systems:

- ▶ User-developed software can be executed without limitation
 - ▶ Apps and open source software can be created and integrated
 - ▶ Functions can be installed afterwards at any time, even at run time
 - ▶ Apps exchange data in real time and non-real time
 - ▶ Security is assured thanks to configurable user administration

[ctrlX AUTOMATION](#) uses Linux, the most stable and reliable real-time operating system in the world. The ctrlX Data Layer is the central element of the architecture. It implements simple and central access to all available system data and parameters including authorization management – and in real time too.

With 8 million potential accesses per second, maximum performance is assured. In addition, the system architecture allows developers to effortlessly implement further system functions at any time as apps and open-source software. The automation platform is therefore available to a vast global community of programmers who create new functions in programming languages of their choice. This accelerates the development of innovations and process improvements.

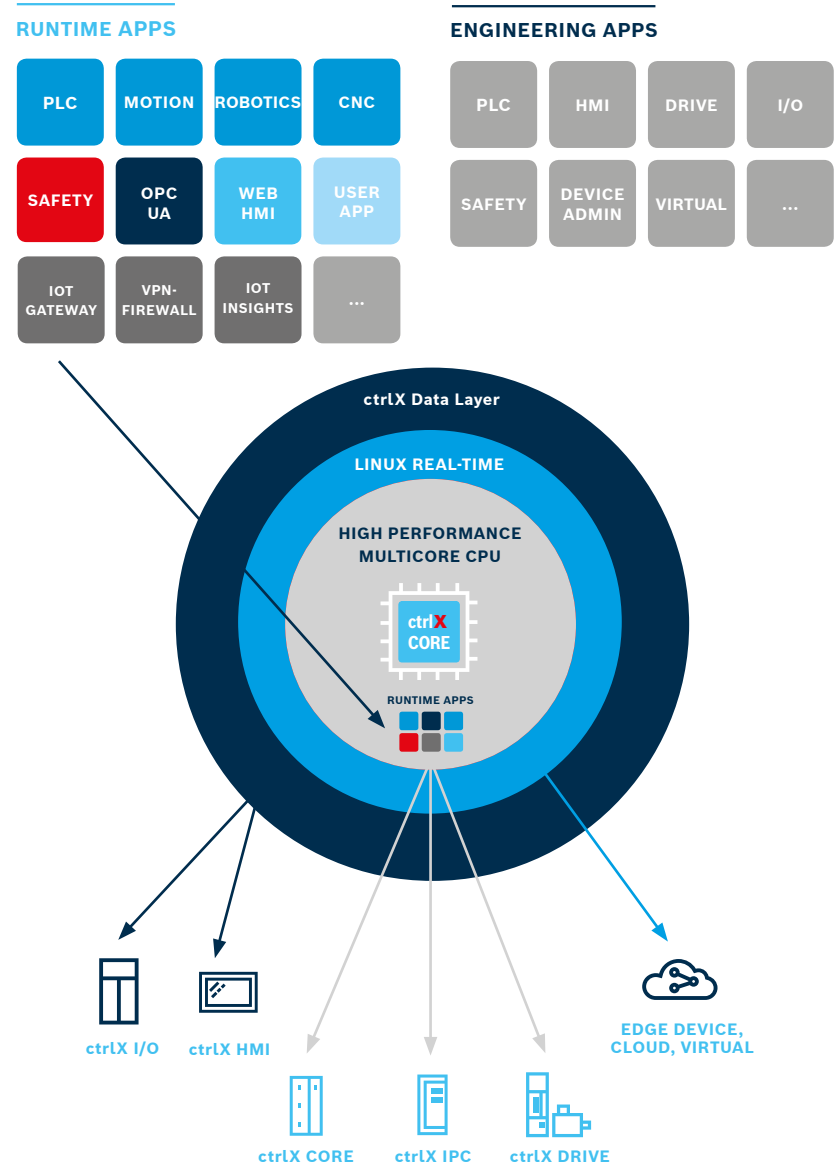

**TODAY'S
TECHNOLOGY.
READY FOR
FUTURE
STANDARDS.**

A close-up, blue-tinted photograph of a server rack panel. The image shows various ports and labels, including 'XG31.1', 'ctrlX SOCIETY', 'PF 30', 'PF 31', and 'XF22 P2'. The text 'ONE OPEN SYSTEM. OPEN-END OPPORTUNITIES.' is overlaid in large, white, bold letters.

**ONE OPEN
SYSTEM.
OPEN-END
OPPORTUNITIES.**

6

THE MOST OPEN AUTOMATION SYSTEM ON THE MARKET

As a universal automation system, [ctrlX AUTOMATION](#) speaks many languages. The system software can be selected, configured, and programmed across all popular programming languages by means of the flexible and modular software and engineering solution, [ctrlX WORKS](#). Developers are therefore not restricted in their choice of development environment and can use different programming languages in their projects. The constantly growing demands with respect to Industry 4.0 / Internet of Things (IoT) applications can therefore be fulfilled with minimum effort, backed by the integrated OPC UA server with its unrivaled range of functions and MQTT protocol support. [ctrlX CORE](#) uses EtherCAT as standard as a real-time Ethernet master. The [ctrlX DRIVE](#) servo drives support the most common real-time Ethernet protocols as a slave connection.



Ultimate technological advantage:

- ▶ Free choice of programming language
- ▶ Key industry standards can be used straight away
- ▶ System functionality can be extended
- ▶ Structured and secure access to data with the ctrlX Data Layer
- ▶ Savings in terms of line control systems because data is available centrally

**CONNECT
TO THE
WORLD WILD
WEB.
SECURE.**

7

UNIQUE IOT INTEGRATION

Integration of the automation world and Internet of Things in the Factory of the Future is an absolute prerequisite for improving competitiveness in the digital age. [ctrlX AUTOMATION](#) offers better connectivity than any other system and can be integrated in all IT, edge, and cloud systems.

Security updates, backups, and upgrades of new software features are performed centrally, simultaneously, and efficiently by means of the ctrlX Device Portal. Future standards such as 5G and OPC UA over TSN are already prepared. A security solution certified according to IEC 62443 ensures secure exchange of data. A VPN extension or firewall installation can also be implemented optionally via app.



Device management:

- ▶ Cloud-based device management via the ctrlX Device Portal
- ▶ Security updates and bug fixing, new function upgrades
- ▶ Backup and recovery of automation projects



IoT integration:

- ▶ IoT Connector for IT systems via OPC UA Client and Server, MQTT
- ▶ Expansion through customer-specific IoT apps
- ▶ Ready for new standards: 5G, OPC UA over TSN ...



Security:

- ▶ Security by default
- ▶ Security by design
- ▶ Certified IT security to IEC 62443
- ▶ Secure production mode

Reliable connectivity:

- ▶ Automated software updates
- ▶ Simple backup and restore
- ▶ Effective protection against cyber attacks

**CODE LOW.
LEVEL UP.**

moveA
ematics name name?
coordinate
show path params

x: 0 y:

8

THE REVOLUTION IN ENGINEERING

With its forward-looking software architecture, [ctrlX AUTOMATION](#) offers a previously unrivaled degree of freedom and efficiency, allowing developers to overcome the challenges of contemporary software development quickly and creatively. In addition to classic PLC and motion functions, they can flexibly design additional functions in numerous programming languages and combine them with one another.

The modular [ctrlX WORKS](#) software solution increases engineering efficiency in this regard by 30 to 50%. Web-based system configuration therefore allows fast and simple start-up without the need to install software. A completely virtual development environment is available for engineering without the use of hardware. Added to this are the online services of the ctrlX Device Portal and the ctrlX Developer Community, which is linked with the GitHub software platform with its forums and how-to videos.

Future-based development:

- ▶ Faster engineering times
- ▶ Rapid implementation of innovations
- ▶ Shorter commissioning times
- ▶ Know-how and security of investment

All options at a glance



STRAIGHTFORWARD START-UP

Web-based access to program code in just a few minutes without software installation



FREE CHOICE OF PROGRAMMING LANGUAGE

IEC 61131, PLCopen, G-Code, C/C#, Python, Java, Node-RED, Blockly...



STRAIGHTFORWARD INDIVIDUALIZATION

- ▶ Own software/IP
- ▶ Third-party provider
- ▶ Open source



UNLIMITED FUNCTIONALITY

Unrestricted expandability through apps



VIRTUAL CONTROL

Unrestricted virtual availability of control and software environment



ONLINE SERVICES

- ▶ ctrlX Device Portal
- ▶ ctrlX Developer Community
- ▶ GitHub

9

LONG-TERM AVAILABILITY AND DIGITAL SERVICES

[ctrlX AUTOMATION](#) sets the standard on the market for the longest product availability. Bosch Rexroth ensures additional availability of all components for at least ten years after the end of the active production availability and therefore secures service capability in the long term. This period can even be extended to a total of 25 years thanks to an optional add-on service.

All service activities for ctrlX AUTOMATION can be initiated directly with the [ctrlX Service](#) App. The ctrlX Device Portal manages all connected IoT devices via the cloud and also enables security updates, parameter backups, secure remote access, etc.

Bosch Rexroth supports machine manufacturers and end users worldwide with a 24/7 service hotline, rapid availability of spare parts at any location as well as repairs. Application specialists provide advice and support during engineering, commissioning, and maintenance.

ctrlX AUTOMATION Service:

- ▶ Service, spare parts, and repairs 24/7 globally
- ▶ Product availability up to 25 years beyond active production
- ▶ The ctrlX Service App enables direct service activities
- ▶ The ctrlX Device Portal allows cloud-based device management

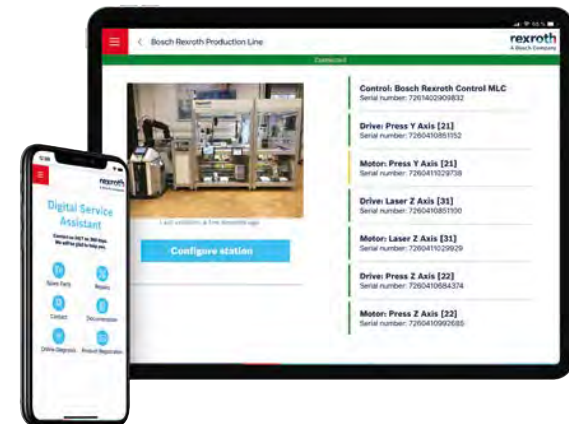

Digital Service

**LIVES LONG
AND PROSPERS.
THANKS TO
LIGHT-SPEED
SERVICE.**



Spare Parts



Repairs



**INVEST IN
CHANGE.
IT'S THE ONLY
CONSTANT.**

10

THE MOST FUTURE-PROOF AUTOMATION SYSTEM

The decision in favor of an automation system and its provider is critical in terms of long-term competitiveness in all sectors. Maximum future-proofing and protection of investment of the products as well as an automation partner that can be totally relied upon are basic prerequisites in this respect.

Bosch Rexroth embraces this responsibility with [ctrlX AUTOMATION](#). Future standards, trends, and extension options have therefore always been at the forefront and continue to play a vital role in its development activities and continue to do so. Thanks to the uncompromisingly open and platform-neutral system architecture at all levels, ctrlX AUTOMATION even today offers the possibility to use future standards such as 5G, OPC UA over TSN, or pending programming languages as soon as they are ready for market. It will therefore also be possible in future for machine manufacturers and users to implement new types of automation concepts, whether intelligent AI systems, central server-based solutions or distributed systems. This ensures full protection of investment and creates trust.

Developed with vision:

- ▶ Uncompromisingly open, no proprietary systems or interfaces
- ▶ Free choice of programming language
- ▶ Hardware-independent software
- ▶ Extremely long availability of all components
- ▶ Ready for future standards such as 5G, TSN, AI etc.

NO PORTFOLIO. JUST OPTIMIZED SERVICE.

ctrlX AUTOMATION: always the right solution

ctrlX WORKS

The software and engineering toolbox

[ctrlX WORKS](#) is the central nervous system of the platform and reduces the engineering time for new concepts by 30 to 50%. In addition to classic PLC languages pursuant to IEC 61131, PLCopen, and G-Code, developers can implement functions without restriction in the form of apps or open source software. Individual functions can be installed and removed without any repercussions for existing apps and also tested virtually. The central ctrlX Data Layer guarantees continual access to all real-time and non-real time data of the installed apps. It is immaterial in this sense whether the apps are installed as runtime apps on a [ctrlX CORE](#) or are executed as engineering apps and services on a PC, smart device, or in the cloud.

ctrlX WORKS already includes an extensive portfolio of high-performance apps for typical tasks in the area of factory automation. In addition, users can develop their own programs in any programming language or integrate third-party apps.

Highlights

More productivity

- ▶ Free choice of programming language
- ▶ Limitless functionality that can be implemented with ease
- ▶ Virtual testing without hardware
- ▶ Simple integration of own and third-party software

Less engineering

- ▶ Web-based engineering
- ▶ Pre-programmed functions and intuitive programming tools
- ▶ Developer communities and services



At a glance:

- ▶ Engineering is up to 50% faster
- ▶ Rapid adaptation to changes on the market

SERVICES



ENGINEERING



RUNTIME APPS



CORE RUNTIME

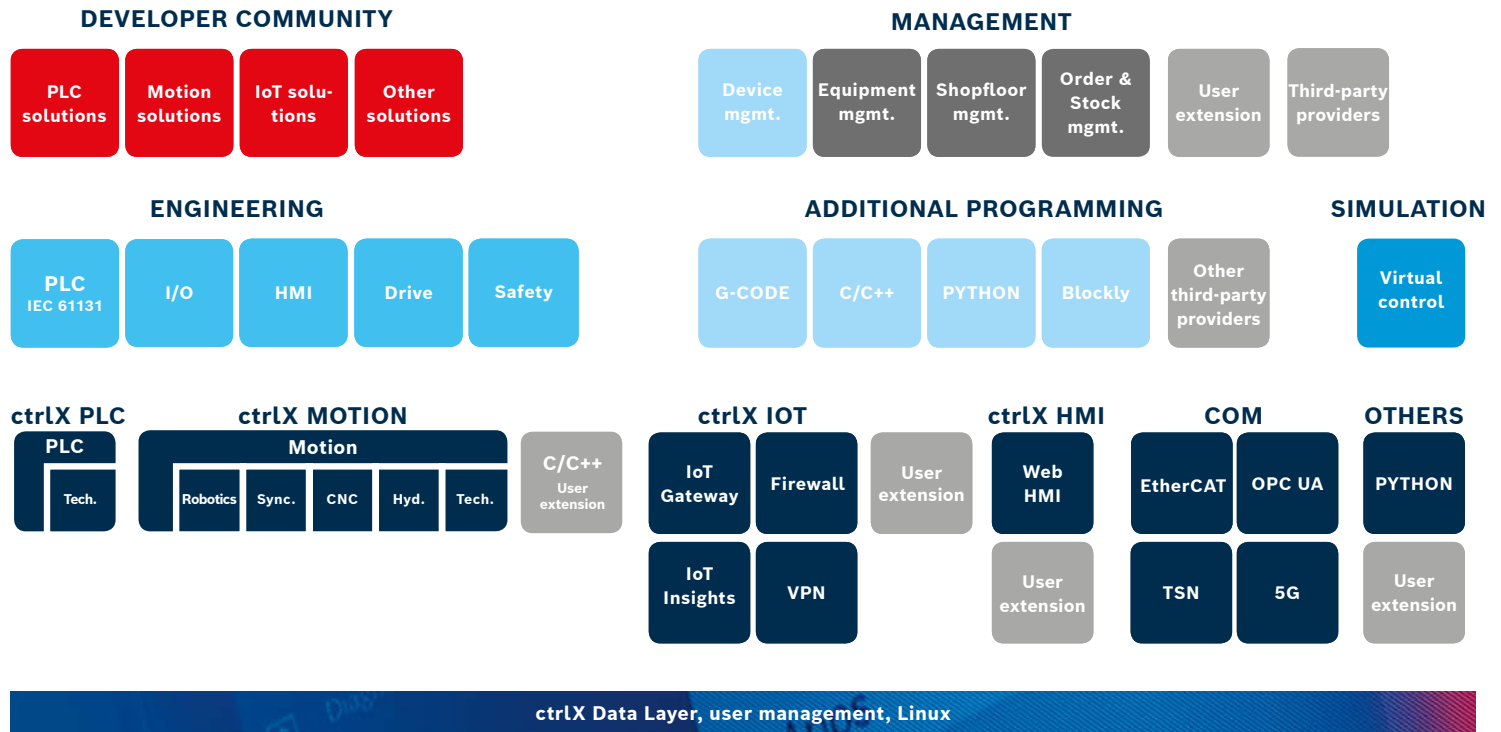

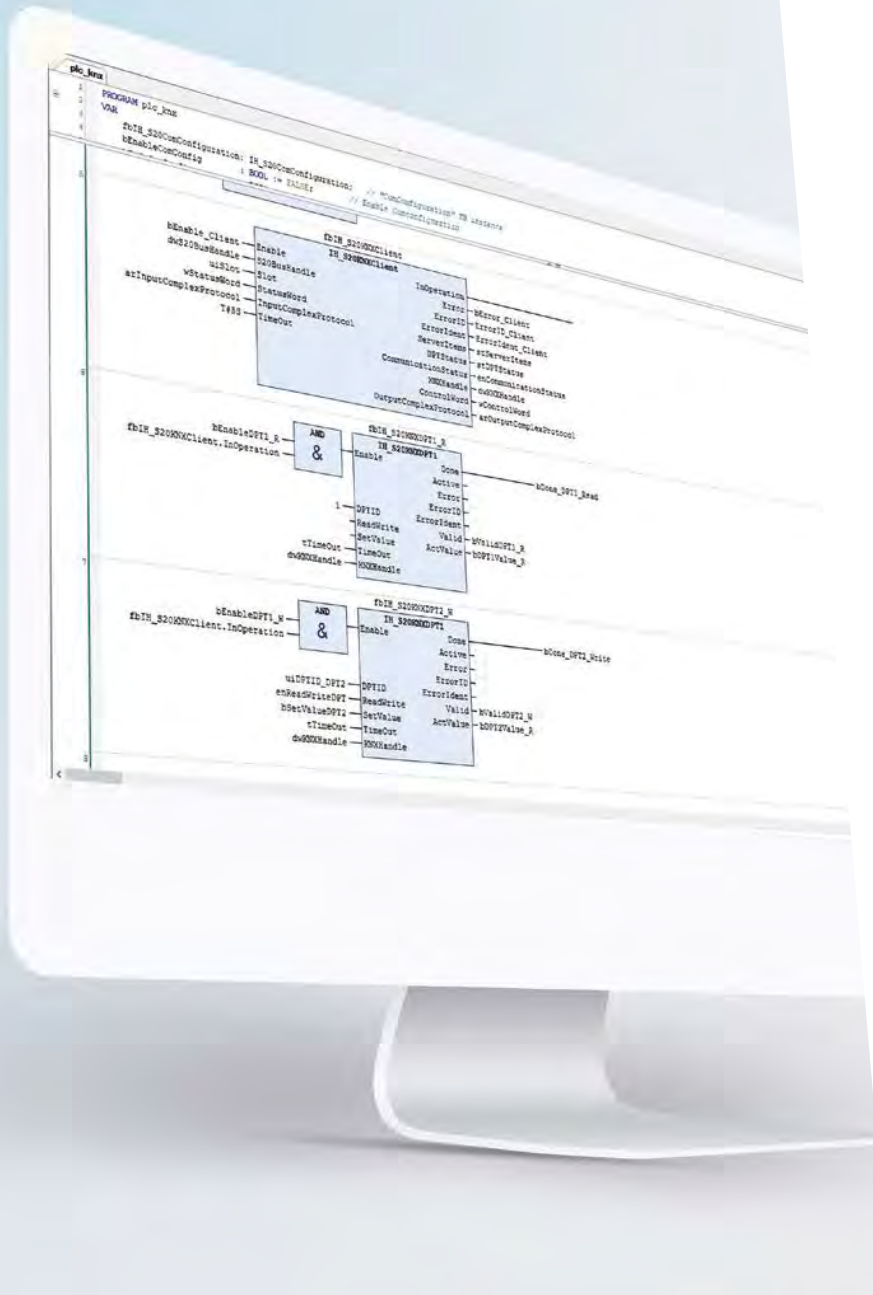

ctrlX PLC

The forward-looking PLC software

ctrlX PLC offers a high-performance PLC control solution and combines the advantages of classic PLC automation with the communication and functional requirements of the Internet of Things – a perfect combination for the Factory of the Future.

Modular principle for targeted application

The flexible use of ctrlX PLC guarantees that the ideal solution is always found for projects that demand high cost-efficiency, even in the case of distributed architectures. Ready-made function blocks and automatic code generation increase effectiveness and efficiency in engineering. In order to define motion sequences and target positions in drives, the corresponding function modules simply need to be called up and combined. Processes are simplified by wizard-controlled programming and the enhanced Generic Application Template with automatic PLC code generation. The open infrastructure enables protected integration of in-house know-how.

Open for networking

The ctrlX Data Layer provides all process and machine data centrally, replacing PLC line control systems. At field level, [ctrlX PLC](#) provides a master function for numerous fieldbuses such as EtherCAT, PROFINET, and EtherNet/IP. The data and information collected is forwarded on the basis of established standards such as OPC UA and MQTT. This means that ctrlX PLC can be integrated in the most varied automation environments.

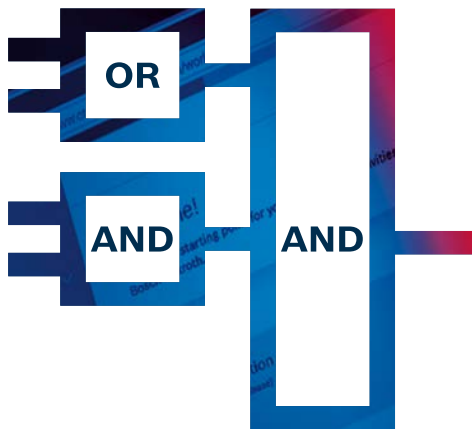

Highlights

More productivity

- ▶ Openness and standards eliminate hardware dependencies
- ▶ Future orientation by design
- ▶ New degree of freedom with the ctrlX Data Layer
- ▶ Increased efficiency thanks to unrestricted choice of programming language

Fewer components

- ▶ Ultra-compact control platform with optimum performance and minimum variance
- ▶ Ultimate functionality and flexibility
- ▶ Savings on logistics, hardware, and assembly costs

Less engineering

- ▶ Know-how development through integration of own applications
- ▶ Free choice of programming language



At a glance:

- ▶ Highest performance, smallest hardware variance
- ▶ Reduced logistics costs
- ▶ Less time needed for familiarization and engineering
- ▶ The ctrlX Data Layer provides all process and machine data centrally, making PLC line control systems redundant



ctrlX IOT

The most modern IoT software

Industry 4.0, the industrial Internet of Things (IoT) or the Factory of the Future: The greatest productivity potential for industrial users lies in networking. That's why [ctrlX IOT](#) is always included as part of [ctrlX AUTOMATION](#). Thanks to full integration of IoT solutions in the hardware, users have boundless possibilities and can start implementation straight away.

Ready to run in less than five minutes

Guided configuration dialogs are used to perform the configuration quickly and intuitively – without the need for programming. End users too can configure or change data connections quickly at the click of a mouse. With more than 30 direct connection options and communication standards, ctrlX IOT offers optimum flexibility for connecting different devices and integrating seamlessly into existing or also future systems. Non-reactive updates ensure an optimum level of machine availability during the production process, even when loading updates. A firewall and VPN access control all access continually in order to protect machine availability. IT security standards pursuant

to IEC 62443 provide enhanced protection against viruses and trojans. At the same time, the solution enables encrypted transmission of data and secure remote services.

Transparency unleashes optimum potential

Whether online or offline: Machine data can be transparently displayed retrospectively for up to six months with IoT Insights. This ranges from production KPIs to notifications for the shift manager to a fault history for service.

By integrating [ctrlX IOT](#) in the Nexeed industrial application system, a universal solution is created from sensor through to cloud applications. Among other features, Nexeed therefore enables central monitoring of machines through to global plant networks.

Highlights

More productivity

- ▶ Maximum production capacity and long-term availability thanks to non-reactive updates during the production process
- ▶ Local storage of machine data for maintenance
- ▶ Fully integrated IT security standards for access control and remote maintenance
- ▶ Seamless integration in the Bosch Nexeed industrial application system

Fewer components

- ▶ IPC and VPN router hardware is reduced to one control platform
- ▶ Cost savings and lower risk of failure thanks to hardware reduction and IT security standards
- ▶ Machine is “Bosch IoT ready”

Less engineering

- ▶ Optimum flexibility for integrating data in existing IT production systems with no programming
- ▶ Simplest handling for machine manufacturers and end users



At a glance:

- ▶ Increased system efficiency thanks to faster exchange of data with the IoT
- ▶ Full integration of automation components
- ▶ Cost savings through reduced engineering work for data connectivity

ctrlX MOTION

The motion, robotics, and CNC software

[ctrlX MOTION](#) sets new standards for openness and scalability. Users can perform the most varied automation tasks with this software: from simple handling tasks to complex robot applications through to highly dynamic machines, such as those used in the packaging and print industry. In this environment, they control multi-axis applications with strict requirements in respect of coordinated movements and synchronicity.

ctrlX MOTION forms the perfect basis for the intelligent automation of production machines. It implements both fast I/O signal processing and highly dynamic motion control tasks – with more than 100 axes per control system. ctrlX MOTION is executable on all [ctrlX AUTOMATION](#) hardware, adapts flexibly to the respective requirements and can be extended at any time.

ctrlX MOTION connects the previously separate worlds of automation and IT with the ctrlX Data Layer. Users can create functions as apps in any programming languages, even graphical ones, and combine them freely. This allows a previously unknown degree of freedom, flexibility, and efficiency.

Guided dialogs for visualization and engineering tasks optimize the project workflow in development and increase productivity through simple integration of innovative functions. Web-based engineering supports fast commissioning and shortens time to market.



Single Axis Motion



CNC



Synchronized Motion



Hydraulic Motion

Highlights

More productivity

- ▶ Shortest PLC and motion cycle times
- ▶ A control system coordinates more than 100 axes
- ▶ Ultimate precision thanks to axis synchronization at microsecond speed and with a nanometer level of precision

Fewer components

- ▶ All applications on one platform (synchronized motion, coordinated motion and hydraulic motion)
- ▶ Maximum scalability ensures the best possible solution in terms of space requirements and functionality

Less engineering

- ▶ The engineering time is reduced by up to 50% thanks to wizard-based development of application software and ultimate ease of programming
- ▶ Can be used for all applications



At a glance:

- ▶ Control system for universal and modern machine automation
- ▶ Cross-platform performance and openness
- ▶ Time-to-market is at least 30% faster
- ▶ Complete and open automation system



ctrlX CORE

The ultra-compact control platform

Nowadays mechanical engineering means software development. The high-performance and communication-ready [ctrlX CORE](#) forms the basis for this. It breaks down the boundaries between the IPC, embedded system, and drive-based platforms. The 64-bit multicore CPUs distribute the applications optimally to the different processor cores. They offer significantly higher computing power than previous control platforms in the same space. ctrlX CORE offers scalable control of single-axis movements through to highly complex multiple axis movements. It implements different technology functions with complex arithmetic operations in parallel with a high control quality and communicates with higher-level systems. Process data can be processed comprehensively by the control system when [ctrlX I/O](#) is activated. Optional I/O modules for additional functions and communication protocols in the same form factor simplify scaling.

Quality down to the tiniest screw

[ctrlX CORE](#) is expressly designed for demanding environments and withstands vibrations and impact in a wide temperature window with high EMC resistance. The hardware is designed for maximum maintenance-free operation and long-term availability based on a fanless and wear part-free design.

At the heart of open communication

Thanks to its open and flexible architecture, ctrlX CORE is ready to meet whatever the Factory of the Future may bring in the future. In addition to EtherCAT, the hardware supports many other common automation protocols. For example, the gigabit Ethernet interface is ideal for use in networked environments, supporting the data-intensive exchange of information with higher-level IT systems, HMI devices and cloud-based applications. The control system supports more than 30 IT and IoT standards, including OPC UA as server and client as well as the widely used MQTT protocol.

Highlights

More productivity

- ▶ Unlimited performance thanks to 64-bit multicore processors
- ▶ Optimum distribution of applications to the CPU cores

Fewer components

- ▶ Flexible extensibility with performance and I/O functions
- ▶ Robust hardware design

Less engineering

- ▶ One control system for all platforms



At a glance:

- ▶ Multicore technology for optimum performance
- ▶ The system that offers the best possible connectivity on the market
- ▶ Open and flexible architecture for new freedom in developing functions

ctrlX I/O

The powerful ctrlX CORE enhancement

With [ctrlX I/O](#), Bosch Rexroth provides the ideal add-on for holistic automation solutions. This add-on connects the EtherCAT ecosystem to the machine control level.

Intuitive use at a new level

The compact I/O portfolio allows simple installation and cabling as well as rapid exchange of individual modules or extensions. Configuration is not required because automatic recognition integrates each module independently. Additional communication standards and interfaces can be integrated via the I/O Performance Line for enabling forward-looking concepts. Based on EtherCAT, ctrlX I/O supports real-time capable data processing. Simple configuration and commissioning shorten engineering times by up to 30%.

Enduring and diagnostic-friendly

ctrlX I/O is designed for use in industrial environments and fulfills the strictest requirements in terms of vibrations, temperature rating, and protection class. Clever diagnostic concepts, on-board sensor systems, or smart module diagnostics via NFC increase machine up-time and speed up diagnostics in the event of errors.





Highlights

More productivity

- ▶ Clever diagnostic concept at module and channel level reduces standstill times
- ▶ Robust design in IP20 protection class for maintenance- and fault-free operation in the control cabinet

Fewer components

- ▶ Up to 20 I/O points on 12 mm installation width
- ▶ Flexible extensibility with performance functions

Less engineering

- ▶ Tool-free assembly thanks to ergonomic mechanical design and PUSH-IN technology
- ▶ Supports the IO-Link standard for integrating intelligent sensors



At a glance:

- ▶ Extensible for holistic automation solutions
- ▶ Intuitive and ergonomic
- ▶ Simple installation and rapid exchange of modules
- ▶ Engineering times are reduced by up to 30%
- ▶ Strictest mechanical requirements
- ▶ Real-time-enabled data processing



ctrlX IPC

The PC-based automation solution

Sophisticated process control systems often require high performance reserves, which [ctrlX IPC](#) provides flexibly and scalably. Thanks to low power loss, the hardware design needs neither a cooling concept nor fans, thus facilitating a long and fault-free operating time. The modular [ctrlX CORE](#) control platform can be integrated in the open ctrlX IPC portfolio via the PCIe interface. This means that the system can be extended by standard components or open source software. Numerous interfaces are available for communication. ctrlX IPC forms the ideal interface between field level and cloud and ensures reliable and secure transmission of large quantities of data.

Security intelligence for large volumes of data

The integrated hardware and software security infrastructure safeguards the application and machine availability at the same time. The hardware robustly withstands impact and vibrations and offers high EMC stability. It is therefore ideal for use in practically any application and environment. The use of high-performance and robust SSD memories from upwards of 64 GB allows future-proof machine designs and offers reliable protection against data loss in the RAID system. All IPCs contain data backup and recovery software as standard on delivery.

Trusted platform modules (TPM 2.0) use encryption software to protect the computer right through from booting until the application is running (security by design). This chip also stores certificates and serves as a hardware key for further protection mechanisms. Windows 10 IoT Enterprise LTSC (Long-Term Servicing Channel) as the operating system is a key component of [ctrlX IPC](#); it was developed specially by Microsoft for networking intelligent devices on the most varied platforms. Linux can likewise be used as the operating system.

Highlights

More productivity

- ▶ Scalable performance from entry-level through to high-end applications
- ▶ The latest hardware with security-by-design integrated TPM chip
- ▶ High long-term availability thanks to maintenance-free hardware without batteries and fans

Fewer components

- ▶ Integration of the [ctrlX CORE](#) industrial control platform
- ▶ Space-saving design with low installation depth

Less engineering

- ▶ Maximum flexibility and modularity
- ▶ Flexible topologies
- ▶ High performance and openness with Windows 10 IoT or Linux
- ▶ ctrlX IPC components are designed strategically for one-person installation



At a glance:

- ▶ Scalable IPC portfolio from entry-level solution to high-end application
- ▶ Maximum flexibility across all performance ranges

ctrlX HMI

The perfect user experience combination

The right information at the right time: ease of use is an increasingly important factor when deciding to purchase a machine. [ctrlX HMI](#) offers machine manufacturers optimum freedom when it comes to implementing the user experience with intuitive user guidance.

Innovative and mobile HMI solution

The portfolio includes small operating panels, tablets, panel PCs, or large stationary displays with a screen diagonal of up to 24". Anti-glare and chemically hardened front glass make display and operating panels ideal for use in harsh everyday production environments. The 16:9 screen size supports multi-touch operation with ten fingers.

The web-based software solution ctrlX HMI adapts every representation automatically to different display sizes and prepares important information clearly at all times. Third-party provider tools can be used additionally, which communicate via standard interfaces such as OPC UA. ctrlX HMI covers all applications reliably – from the simplest process controls through to demanding and dynamic simulations.



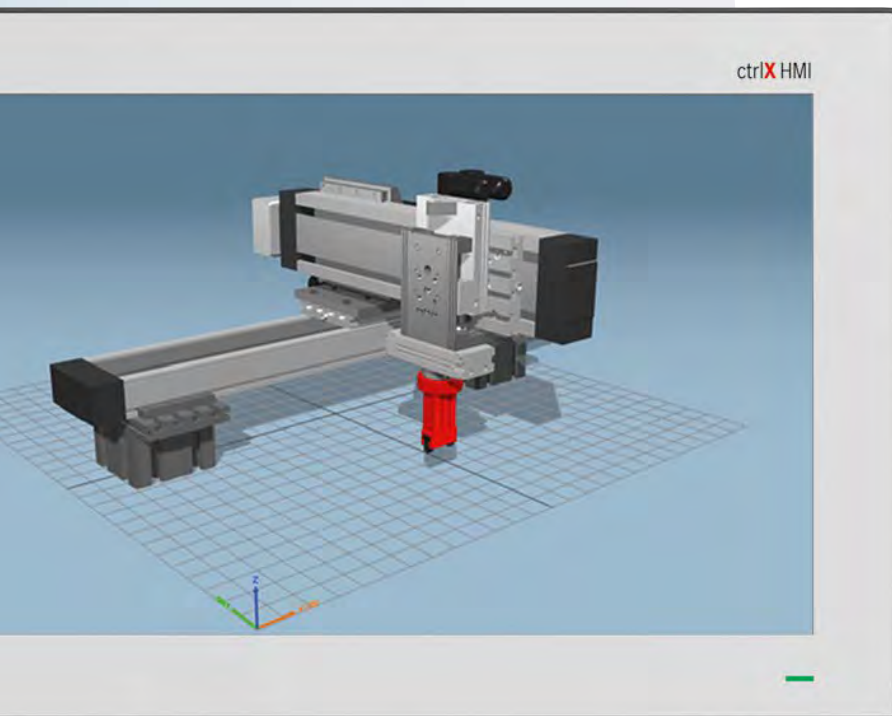

Highlights

More productivity

- ▶ Scalable portfolio from small operating panels through to 24" displays

Fewer components

- ▶ Web-based HMI with integrated web server

Less engineering

- ▶ Integrated web-based HMI engineering and simple integration of third-party provider HMI tools
- ▶ Integration of 10" smart devices for the mobile HMI solution



At a glance:

- ▶ Perfectly harmonized hardware and software for intuitive visualization
- ▶ Robust hardware
- ▶ Long life cycle

ctrlX DRIVE

The most compact drive system

Bosch Rexroth has developed the most compact modular drive system in the world for its customers with [ctrlX DRIVE](#). Apart from space-saving dimensions and maximum scalability, ctrlX DRIVE boasts advantages such as virtually unlimited combination options for users, sophisticated engineering tools, and high energy efficiency.

Flexible supplier concept

The new drive generation offers both simple single-axis applications and complex multi-axis machine systems. The scalable drive portfolio includes converters, single and dual-axis inverters, DC/DC converters, and power and regenerative supply units. ctrlX DRIVE therefore offers tailored solutions with peak currents of 6A to 375A. Sufficient power is always available even for extensive machine designs with output of up to 260kW.

Space requirements are halved

The powerful [ctrlX CORE](#) control hardware can be integrated in the drive housing without needing additional space. Overall users save up to 50% in the control cabinet. Further space savings are possible in combination with the modern MS2N motors, since they offer a power density that is up to 30% higher.

Complete performance package

All components in the ctrlX DRIVE system can be combined freely with one another. Users can extend the drives with additional hardware and software functions with the ctrlX DRIVE^{plus} option. Add-on boards for additional encoders, I/O extensions, and the integrated ctrlX CORE control system offer previously unattainable degrees of freedom.



-50%

Secure and energy-efficient

With a reaction time of around 4 ms, [ctrlX DRIVE](#) offers one of the fastest SafeMotion solutions on the market. The energy management functions enable energy to be exchanged in the link connection and central network access components. The patented Smart Energy Mode reduces peak power of the drives by up to 70%. The converters can be used at the same time as supply units and inverters. In addition, classic power and regenerative supply units are also available. The continuous DC bus optimizes the power requirement and reduces power loss.



At a glance:

- ▶ Most consistent drive system on the market
- ▶ Space savings of up to 50%
 - ▶ Cost-efficient entry-level solution through to high-end solution with integrated motion control





Robust design

[ctrlX DRIVE](#) has a robust EMC design. The new power connector with integrated grounding concept allows even better interference resistance. The integrated DC bus connection eliminates accessory sets and is designed for high ampacity (up to 375 A).

Highlights

More productivity

- ▶ Peak currents of 6A to 375A
- ▶ Converters, power and regenerative supply units with peak power of up to 260kW
- ▶ Flexible power supplier concept – space saving, flexible, and energy-efficient

Fewer components

- ▶ Up to 50% less space is required in the control cabinet
- ▶ Perfect for 300mm control cabinets owing to modular multi-axis concept
- ▶ Integrating [ctrlX CORE](#) eliminates the space required for the control system fully

Less engineering

- ▶ Intelligent functions such as multi-Ethernet, multi-encoders, integrated web servers allow simple diagnostics
- ▶ Less wiring and faster engineering
- ▶ Single-cable technology

The high-performance servo motors

Bosch Rexroth servo motors are the perfect team player in the [ctrlX DRIVE](#) portfolio. Boasting compact dimensions, they combine optimum dynamics with maximum precision of position, speed, and torque values.

Motors for every requirement

The broad model portfolio includes the right solutions to meet all requirements. An ATEX-compliant series is therefore available

for environments with explosive gases and dust. The rotary and linear direct drives in the MS2N motors dispense with mechanical transmission components like coupling and gears. The innovative single-cable technology with cable length of up to 75m reduces the cabling effort by 50%.

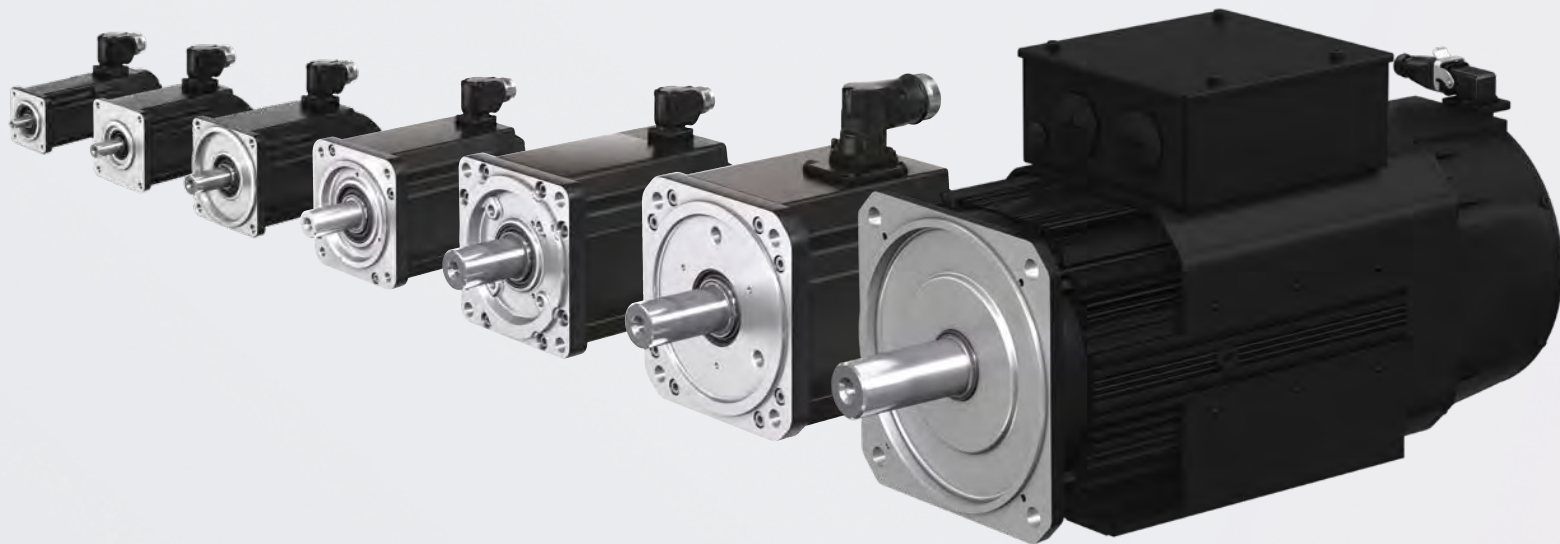

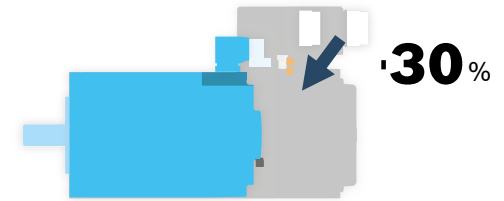

Engineering for experts

Developers have access to the digital twin of the motor, which is stored in a design tool and in the [ctrlX DRIVE](#) controller. Planning and design of even complex drive systems can therefore be virtualized quickly and reliably. A new torque model transforms each motor into a data source for intelligent machines or Industry 4.0 applications.

Highlights

More productivity

- ▶ High torque density for greater power
- ▶ 7 frame sizes with maximum torque of up to 692 Nm
- ▶ Maximum dynamics of the servo axes due to low motor inertia and high overload capacity

Fewer components

- ▶ Robust single-cable connection with a cable length of up to 75 m
- ▶ MS2N with integrated SafeMotion encoder – no further safety components are required
- ▶ Motor as torque sensor makes external sensors redundant

Less engineering

- ▶ Plug-and-play expanded encoder data memory for faster commissioning
- ▶ Digital twin of the thermal motor model

rexroth ctrlX DRIVE



PF 01

XG21.2

XG31.2

XG21.1

XG31.1

ctrlX
SAFETY

XG41

PF 30

PF 31

XF22 P2

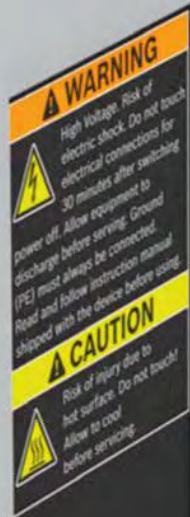

ctrlX SAFETY

The most comprehensive SafeMotion and SafeLogic solution

Safety first: standardized safety is an absolute prerequisite for machine manufacturers and users. [ctrlX SAFETY](#) simplifies implementation of standardized safety while ensuring maximum productivity during usage.

Certified safety as standard

The new [ctrlX DRIVE](#) drive generation is fitted systematically with extensible safety functions. SafeMotion implements safety functions precisely where motion occurs and responds within 4 ms. Of particular interest for modular concepts is that manufacturers can use SafeMotion to implement a purely drive-based safety solution in their assemblies, which operates independently of the higher-level control system.

SafeLogic safety control is an optional and compact extension of the standard control system. Graphical programming simplifies engineering and reduces the familiarization time.

SafeMotion and SafeLogic as a package solution

SafeMotion and SafeLogic together communicate via Bosch Rexroth's own safety bus at a speed that is 10 to 15 times faster than via classic fieldbuses. Safety equipment can therefore be designed more compactly thanks to the fast reaction times.

[ctrlX SAFETY](#) covers the full range from entry-level solutions to highly complex applications with different packages. Once they have been created, safety solutions can be integrated into different machine designs without any major adaptations. ctrlX SAFETY simplifies engineering in the process too through dialog-based acceptance tests. Intelligent software modules simplify parameterization in this context. The unrestricted choice of bus systems ensures perfect communication between components.

Highlights

More productivity

- ▶ Fastest safety solution on the market with reaction times of 4 ms
- ▶ Optimum integration into machine concepts

Fewer components

- ▶ Less hardware thanks to software-based scaling
- ▶ Space savings owing to faster reaction times by the system

Less engineering

- ▶ Simplified creation of application programs through graphical programming of the safety logic and dialog-based support for the acceptance test



At a glance:

- ▶ Fast and adaptable, can be used individually or as an overall system
- ▶ The reaction time of the safety solutions enables a more compact design
- ▶ Maximum safety in production



ctrlX Configurator

The intuitive tool for a systemic automation solution

The [ctrlX Configurator](#) supports the complete [ctrlX AUTOMATION](#) portfolio and enables individual configuration of automation solutions – simply, quickly, and reliably. Users create the desired system topologies graphically without product knowledge. Support or the offer can be queried directly from the configuration. Round the clock – worldwide.

- ▶ Graphical configuration of components and complete automation solutions
- ▶ Intuitive handling via modern operating concept with dynamic 3D product view
- ▶ Individual problem-solving without product know-how with manufacturer-independent product library
- ▶ Faster configuration via solution templates and 24/7 availability of the online platform
- ▶ System-wide consistency of the solution configuration through automatic verification of product relationships
- ▶ Support for processing in project teams and for support and availability queries

Bosch Rexroth AG
Bgm.-Dr.-Nebel-Str. 2
97816 Lohr, Germany
www.ctrlx-automation.com
www.boschrexroth.com/automation

© Bosch Rexroth AG November 2019
Subject to change without notice.

This information is only provided to describe the products. No statements concerning a certain condition or suitability for a certain application can be derived from our information.

The information given does not release the user from the obligation of own judgment and verification. It must be remembered that our products are subject to a natural process of wear and aging.

The data provided is based on average or maximum values and may vary.

**Factory of
the Future**
Now. Next. Beyond.

rexroth
A Bosch Company